

**Technical Report
1164**

Microgrid Study: Energy Security for DoD Installations

**S.B. Van Broekhoven
N. Judson
S.V.T. Nguyen
W.D. Ross**

18 June 2012

Lincoln Laboratory
MASSACHUSETTS INSTITUTE OF TECHNOLOGY
LEXINGTON, MASSACHUSETTS



Prepared for the Office of the Secretary of Defense under Air Force Contract FA8721-05-C-0002.

Approved for public release; distribution is unlimited.

This report is based on studies performed at Lincoln Laboratory, a federally funded research and development center operated by Massachusetts Institute of Technology. This work was sponsored by the Office of the Secretary of Defense under Air Force Contract FA8721-05-C-0002.

This report may be reproduced to satisfy needs of U.S. Government agencies.

The 66th Air Base Group Public Affairs Office has reviewed this report, and it is releasable to the National Technical Information Service, where it will be available to the general public, including foreign nationals.

This technical report has been reviewed and is approved for publication.

FOR THE COMMANDER



Gary Tutungian
Administrative Contracting Officer
Enterprise Acquisition Division

Non-Lincoln Recipients

PLEASE DO NOT RETURN

Permission has been given to destroy this document when it is no longer needed.

**Massachusetts Institute of Technology
Lincoln Laboratory**

Microgrid Study: Energy Security for DoD Installations

*S.V.T. Nguyen
Group 74*

*S.B. Van Broekhoven
Group 77*

*N. Judson
W.D. Ross
Group 99*

Technical Report 1164

18 June 2012

Approved for public release; distribution is unlimited.

Lexington

Massachusetts

This page intentionally left blank.

EXECUTIVE SUMMARY

Growing concerns about the vulnerability of the electric grid, uncertainty about the cost of oil, and an increase in the deployment of renewable generation on domestic military installations have all led the Department of Defense (DoD) to reconsider its strategy for providing energy security for critical domestic operations. Existing solutions typically use dedicated backup generators to service each critical load. For large installations, this can result in over 50 small generators, each servicing a low voltage feeder to an individual building. The system as a whole is typically not well integrated either internally, with nearby renewable assets, or to the larger external grid. As a result, system performance is not optimized for efficient, reactive, and sustainable operations across the installation in the event of a power outage or in response to periods of high stress on the grid. Recent advances in energy management systems and power electronics provide an opportunity to interconnect multiple sources and loads into an integrated system that can then be optimized for reliability, efficiency, and/or cost. These integrated energy systems, or **microgrids**, are the focus of this study.

The study was performed with the goals of (1) achieving a better understanding of the current microgrid efforts across DoD installations, specifically those that were in place or underway by the end of FY11, (2) categorizing the efforts with a consistent typology based on common, measurable parameters, and (3) performing cost-benefit trades for different microgrid architectures. This report summarizes the results of several months of analysis and provides insight into opportunities for increased energy security, efficiency, and the incorporation of renewable and distributed energy resources into microgrids, as well as the factors that might facilitate or impede implementation.

In our cost-benefit trades, we have focused on resources that have been commonly used in the DoD to date. A wide range of traditional generation options and different renewable resources could be implemented into a microgrid; covering the entire spectrum of possibilities was outside the scope of this study. Over the course of the study, more than 75 people were contacted within all the military services, the Office of the Secretary of Defense, the Department of Energy (DOE), and the DOE laboratories. Forty-four installations were identified that either had existing microgrids, planned installation of microgrids, or conducted microgrid studies or demonstrations at their facilities. The aggregate 53 efforts at these installations were then categorized based on several key attributes including size, maturity, the inclusion of renewable resources, and the ability to operate in a grid-tied manner. The results of this survey are presented in Section 3.

Preliminary cost-benefit trades were conducted to better understand how different environmental factors affected the choice of optimal microgrid architecture. Environmental factors in this context include location-dependent weather conditions, the properties of a given installation such as demand profile and land availability, and the limiting characteristics of the local electric grid and utility rate structures. Section 4 further describes the environmental conditions that strongly influence the costs and performance of DoD installation microgrids.

The analysis then compares several different high-level microgrid designs, presenting the cost of each as a function of the energy security provided by the architecture. Cost is specified as a net present value (NPV) given a 30-year project lifetime and a real discount rate of 2%. Energy security is specified as the number of days that an installation would be able to disconnect from the larger electric grid and operate as a stand-alone system, or “island.” The four different architectures that are analyzed are

- Backup diesel generators that cannot operate in parallel with the local utility
- Backup diesel generators that can parallel and participate in a demand-response program
- Backup generators with solar PV integrated into a microgrid (fully islandable)
- Same as above, but with battery storage to allow higher penetrations of solar photovoltaic (PV)

These four cases are analyzed for three representative locations: Navy Base San Diego in San Diego, California, MIT Lincoln Laboratory on Hanscom AFB in Lexington, Massachusetts, and the Naval Support Facility Dahlgren in Dahlgren, Virginia.

The results of this analysis show that the most cost-effective microgrid solutions will be those that take into account the needs of the local commercial electric grid and implement their systems so that they can earn value helping to meet those needs. In areas where commercial generation sources are stretched thin or with significant congestion on the electric grid, local generation can play an important role. A number of DoD installations enlist their backup generation resources in emergency demand-response programs, which aim to alleviate short-term congestion problems in the commercial transmission infrastructure. In these programs the installation is given a periodic credit on their electricity bill for promising to reduce the installation’s demand, either through load shedding or by turning on backup generators, when provided with a signal by the local utility. Analysis shows, and several installations have confirmed, that the financial savings from these demand-response programs more than pay for the cost of generation assets.

In many areas of the country, solar PV generation is approaching, or has already reached, grid parity prices. Solar PV on military installations can be particularly attractive, since the land may be provided at reduced or no cost and the location, next to a large customer, may mean new transmission infrastructure is not required. As a result, the DoD has begun installing significant quantities of PV on a number of installations. If these solar generation resources were to be available to the microgrid during islanded operation, they could significantly extend the islanding time for the installation. Typical solar PV systems have anti-islanding provisions; therefore, both technical and contractual barriers need to be resolved prior to installing solar PV on DoD installations, if the system is to provide energy security benefits.

For particularly promising PV locations, or those installations with requirements for extended off-grid operation, microgrids with very high PV penetration may be the most effective solution. These microgrids have a number of technical concerns, particularly power quality issues that arise with isolated

low inertia electric grids. A number of technologies, including batteries and flywheels, could help ameliorate this problem, but further research and development will be required.

For DoD installations located in wholesale electricity markets, there is an opportunity to enlist microgrid assets into the ancillary services market and potentially pay for a significant portion of the assets cost. The highest value ancillary services, including frequency regulation and spinning reserves, require a fast response to signals from the utility system. The technologies on more advanced microgrids, including energy storage and automated load management, are well suited to participate in this market during grid-tied operation. No existing installation microgrid has demonstrated the level of tight coupling with the utility energy management system and with the energy markets that would be required to benefit from these opportunities. The definition of a robust, cyber secure, interface between the microgrid and macrogrid that allows for coordination on short timescales is, however, an active area of research and will be a key determinant of the economic viability of more advanced microgrid architectures.

This page intentionally left blank.

TABLE OF CONTENTS

	Page
Executive Summary	iii
List of Illustrations	ix
List of Tables	xi
1. PROBLEM DEFINITION	1
1.1 Microgrid definitions	2
1.2 Study scope	3
2. STUDY APPROACH	5
3. OVERVIEW OF MILITARY MICROGRID EFFORTS	7
3.1 Description and classification of microgrid efforts	8
3.2 Detailed description of several efforts	13
3.3 Summary	20
4. ENVIRONMENT	23
4.1 Location-dependent characteristics (resources and weather)	23
4.2 Domestic electric grid characteristics	25
4.3 Department of Defense installation characteristics	35
5. MODELING AND ANALYSIS	39
5.1 Description of microgrid architectures	39
5.2 Analysis methodology	42
5.3 Analysis inputs	45
5.4 Analysis results	56
6. RECOMMENDATIONS	65
APPENDIX A. BRIEF DESCRIPTIONS OF MICROGRID EFFORTS	67

APPENDIX B. FY 2012 ESTCP INSTALLATION ENERGY DEMONSTRATIONS: MICROGRIDS	81
APPENDIX C. EPA DIESEL EMISSIONS STANDARDS	83
References	85

LIST OF ILLUSTRATIONS

Figure No.		Page
1	Assessment approach.	5
2	Military microgrid locations.	8
3	Key microgrid parameters.	9
4	Types of microgrids.	10
5	Classification of existing DoD microgrid efforts by type, maturity, and size.	11
6	Solar PV resources in the U.S.	23
7	Wind resources in the U.S.	24
8	Major components of the electric grid.	25
9	Subdivision of the North American grid.	26
10	Balancing authorities and NERC regional entities.	27
11	ISO/RTO boundaries and military installations.	28
12	Generation and load balance.	29
13	Balancing authorities, utilities, and DoD installations in California.	30
14	Ancillary services pricing for California ISO, 2011.	32
15	Required response time and duration of operating reserves.	32
16	Payback for DLA demand-response programs in PJM (2009).	33
17	Faster response time results in greater benefits in the ancillary services market.	34
18	Laws and Executive Orders mandating changes in energy generation and use.	36
19	Microgrid architectures.	40

20	Island time profile with seven-day minimum.	43
21	CDF of island time for seven-day minimum.	44
22	Estimated total installation cost of generators.	47
23	NREL modeled 2011 installed system price for solar PV.	48
24	Estimated cost projection of lithium ion batteries.	49
25	Hourly power demand profiles.	50
26	Hourly power demand for MIT LL in MW.	50
27	Hourly demand profile for NSF Dahlgren in MW.	51
28	Hourly power demand for NBSD in MW.	51
29	Energy demand profile for seven-day island time.	52
30	CDF for energy demand for seven-day island time minimum.	53
31	Cost of electricity for NBSD, MIT LL, and NSF Dahlgren.	54
32	CDF of electricity cost for NBSD, MIT LL, and NSF Dahlgren.	54
33	Average solar radiation for NBSD, NSF Dahlgren, and MIT LL.	55
34	CDF of total solar energy for seven-day islanding time.	56
35	Allowed initial generator cost increase for a range of demand-response payback rates.	57
36	Required average cost of electricity for solar PV to reach grid parity.	58
37	Worst case total daily solar energy per m ² .	60
38	Potential fuel saved per 1MW of solar PV.	60
39	NPV for MIT LL.	62
40	NPV for NBSD.	62
41	NPV for NSF Dahlgren.	63
42	EPA's emissions regulations schedule from NSPS.	83

LIST OF TABLES

Table No.		Page
1	Analysis Inputs	46
2	Cost Competitiveness of Solar PV	59

This page intentionally left blank.

1. PROBLEM DEFINITION

This study explores how to provide increased, cost-effective energy security for domestic Department of Defense (DoD) installations. Energy security is the ability of an installation to access reliable supplies of electricity and fuel and the means to use them to protect and deliver sufficient energy to meet critical operations during an extended outage of the local electric grid. Though there are a number of approaches to increased energy security, including improvements to the commercial electricity transmission and distribution infrastructure, this study focuses solely on improvements that could be made within the installation's fence line.

The U.S. electric grid, hailed as the “supreme engineering achievement of the 20th Century” by the National Academy of Engineering [1], is a highly complex system comprising over six million miles of transmission and distribution lines owned and operated by over 3,000 diverse organizations. Often referred to as “antiquated” or “broken” [2], the efficiency of the U.S. grid has actually improved steadily over the last century and the number of outages is on par with that of other developed countries. Still, regional power outages do occur, such as the Northeast Blackout of 2003 or the more recent Southern California Blackout of September 2011. In addition, as relatively large energy customers that are frequently situated in remote locations, DoD installations are commonly located at the end of transmission feeders. This leaves them particularly vulnerable to service disruptions from natural causes such as downed power lines. Recent reports have also highlighted the vulnerability of the electric grid to concerted attacks from adversaries, particularly cyber-based attacks which could disable portions of the grid for extended periods.

The purchase and maintenance of backup power generation equipment on-base is a common means of ensuring continuity of operation during a disruption of the electricity supply. It is common for critical loads on installations to have dedicated backup generation sources, with the different military services providing varying guidance as to the required quantity of backup fuel that needs to be present. Moving from the prevalent model of single backup generators to a network of power generation and distribution equipment with intelligent controls offers a largely untapped opportunity to provide significant additional benefits to the installation. These benefits include

- Increased reliability at a lower overall cost—The networking of sources allows fewer generators to be used and still achieve standard reliability criteria (n-1, n-2, etc.¹). Multiple generators can also run on multiple types of fuel, allowing diversification of the supply chain.
- Greater efficiency, which can lead to lower costs—Networking generation assets allow for load sharing, allowing fewer generators to run at higher load factors and therefore with greater

¹ n-1 is a resiliency criterion that requires continued availability of the power network if any single asset were to fail.

efficiency. If the installation is running the generators often, the increased efficiency will lead to fuel and cost savings.

- Enabler for the integration of renewable generation—The DoD is operating under a variety of federal mandates to increase the proportion of electricity generated from renewable sources on domestic installations. In order for these renewable resources to provide increased energy security, an intelligent electric power system will be required.
- Ability to generate cost savings by using backup generation assets during normal operation—Depending on an installation’s location, the local utility may provide a number of pricing structures that the installation can use to generate financial gain from the backup generation resources on-site. These include participating in a demand-response program, peak-shaving, or participating in the ancillary services market.
- Ability to generate financial gain by exploiting advanced ancillary services—During grid-tied operation there is an opportunity for energy storage devices or aggregated loads to participate in the ancillary service markets that require near real-time operation. These services, including frequency regulation and spinning reserves, typically are valued more highly than resources that respond on longer timescales.

The intelligent energy management system with local generation assets described above is oftentimes referred to as a **microgrid** and is the primary focus of this research.

1.1 MICROGRID DEFINITIONS

A large number of microgrid definitions exist from industry, government, and academia. The closest to a U.S. Government–approved microgrid definition is that developed by the Department of Energy (DOE) Microgrid Exchange Group:

“A microgrid is a group of interconnected loads and distributed energy resources within clearly defined electrical boundaries that acts as a single controllable entity with respect to the grid. A microgrid can connect and disconnect from the grid to enable it to operate in both grid-connected and island-mode [3].”

Requiring that the microgrid can operate in parallel with the electric utility grid leaves out a large number of systems on DoD installations that include multiple integrated generation sources and loads, but are not able to parallel with the grid. The goal of this study is to explore systems that provide energy security for DoD installations, and therefore begins with a very broad definition.

In addition to the requirement to operate in parallel with the utility system, the DOE microgrid explicitly requires the microgrid to act as a “single controllable entity” with respect to the grid. This requires a degree of integration with the utility energy management system (EMS) that exceeds current practice within the DoD. Tighter integration with the utility system will likely provide significant

financial benefits to future installation microgrids, as discussed in Section 4.2.3, and is the focus of R&D efforts within the DoD. However, the criterion applied in this report only requires that sources and loads act as an “integrated system” and not as a single controllable entity.

The definition provided here is not meant to supplant the DOE definition; instead its purpose is to provide a common reference frame for the remainder of this document. The DoD definition, provided below, does require the system to be able to disconnect from the grid, thereby distinguishing microgrids from the utility infrastructure used to supply physical islands, such as the Kwajalein Atoll, and from tactical microgrids that supply power to forward operating bases. Tactical microgrids have very different operational goals and mission constraints than DoD installation microgrids and will not be discussed in this report.

“A DoD installation microgrid is an integrated energy system consisting of interconnected loads and energy resources which, as an integrated system, can island from the local utility grid and function as a stand-alone system.”

Ultimately the precise definition of “microgrid” will only become important when it is tied to a specific funding or regulatory mechanism. For this report, the above DoD installation microgrid definition will be used.

1.2 STUDY SCOPE

There are three primary components of this research. First, a survey of DoD microgrids was conducted and the disparate efforts across the DoD have been categorized and are described. Second, the different architectures identified during the survey are analyzed for the level of energy security provided at a given cost. Finally, key parameters are identified that significantly influence the optimal selection of a microgrid architecture.

Domestic electricity markets are going through a period of significant transformation, and the costs and services available to DoD installations are likely to change appreciably in the coming years. New technologies are continuously being introduced to the market, particularly in the area of renewable generation and energy storage. As the prices of these technologies fall, they will have a significant impact on cost-benefit trades for different microgrid architectures.

As such, the findings in this report should be considered interim conclusions. The optimal selection of DoD energy security microgrid architectures and the added costs of energy security are challenging questions that require detailed assessments. The modeling and analysis presented in Section 5 are done at a fairly high level, but all of the assumptions are stated clearly, and areas in need of more detailed analysis are identified. This initial study attempts to begin framing this important issue and presents key areas in need of further study.

This page intentionally left blank.

2. STUDY APPROACH

Achieving the goals of this study, as described in Section 1, begins with assessing the financial tradeoffs of different microgrid architectures that provide increased energy security for DoD fixed-site installations. The first step in this process is to better understand the existing, ongoing, and planned microgrid efforts across the DoD. Next, the performance of these different microgrid architectures is assessed for a given mission and as a function of varying environmental factors. (In this context, “environmental factors” refers to not only the availability of natural resources such as sunlight and wind, but other location-dependant conditions such as the regulatory environment, base-dependent conditions such as demand profile and existing infrastructure, and utility-dependent conditions such as pricing structure and capacity.) Figure 1 illustrates this assessment approach.

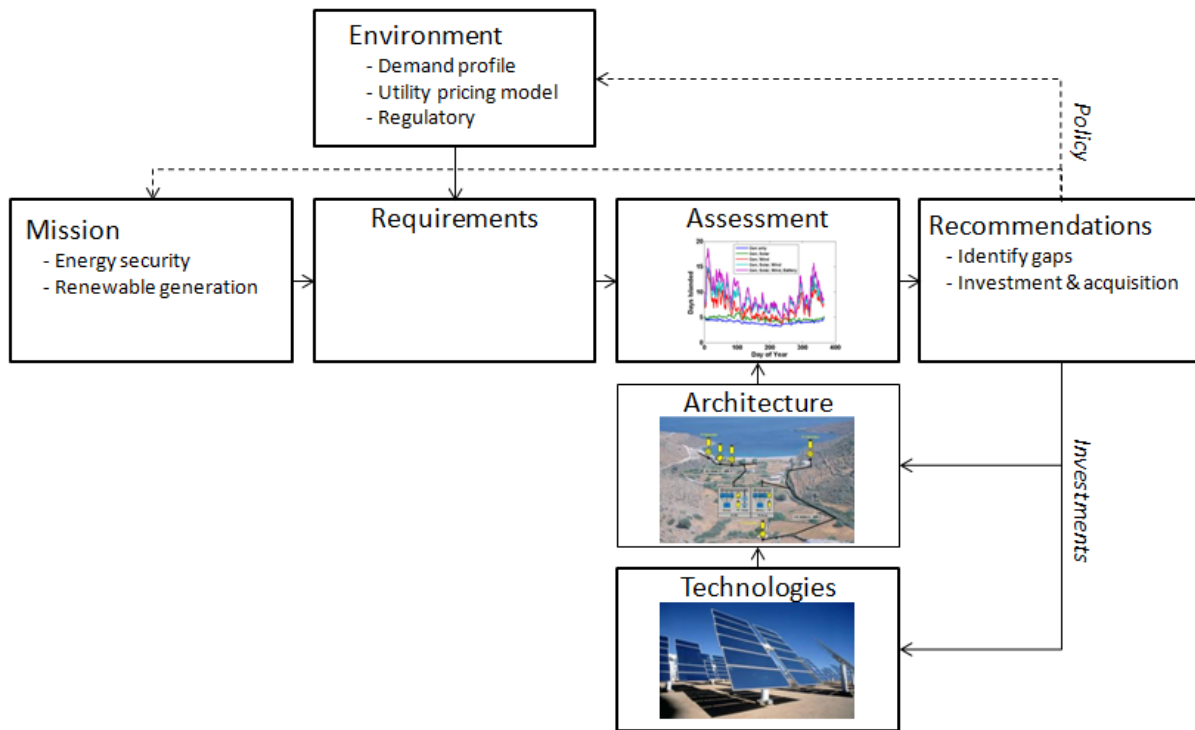

Figure 1. Assessment approach.

There are a number of metrics that can be used to describe the energy security aspects of a microgrid. These include resiliency to different threats and the overall system reliability. To simplify the

presentation of results, a single metric is used in this study to quantify energy security. This metric is the length of time a microgrid can supply critical loads while disconnected from the utility grid, referred to here as islanding time.

Given the mission of **maximizing islanding time for minimum cost**, different microgrid architectures are analyzed under varying environmental conditions. These architectures include a mix of traditional and renewable generation technologies and varying levels of energy storage, as well as different levels of interaction with the commercial electric grid. The microgrid architectures are analyzed for three different locations: Navy Base San Diego in San Diego, California, MIT Lincoln Laboratory on Hanscom AFB in Lexington, Massachusetts, and Naval Support Facility Dahlgren in Dahlgren, Virginia. For each of these locations, the demand profile, the local energy resources, and the local electricity prices are used in the analysis. The result of this assessment is a set of recommendations. These recommendations can be

- technology investments that enable new microgrid architectures **or**
- policy recommendations that can influence either the mission or the environment, particularly the regulatory environment, for the installation.

Section 3 discusses current DoD installation microgrid efforts, classifies the different efforts based on several key attributes, and includes a more detailed discussion on several of the larger efforts. Section 4 discusses the different environmental factors that play a key role in the optimal microgrid architecture, including the structure of the local commercial grid, the attributes of a given installation, and the energy resources available in different parts of the country. Section 5 discusses the initial analysis including tradeoffs of different architectures as a function of location. Section 6 offers recommendations and identifies areas where additional work is needed.

3. OVERVIEW OF MILITARY MICROGRID EFFORTS

To assess the different microgrid architectures already being explored within the DoD, discussions were held with over 75 personnel involved with DoD microgrids. From these discussions, a list of installations that qualify as microgrids was generated, and the different efforts could be categorized based on several key attributes. The criteria used to define a microgrid for this study was given in Section 1.1 but is repeated below.

“A DoD installation microgrid is an integrated energy system consisting of interconnected loads and energy resources which, as an integrated system, can island from the local utility grid and function as a stand-alone system.”

Figure 2 shows the geographic distribution of the different microgrid efforts within the DoD that meet these criteria. It also shows several installations that may qualify, but that could not be confirmed over the course of this study. This survey should be considered a snapshot taken at the end of FY 2011, as installations continuously refresh their capabilities.

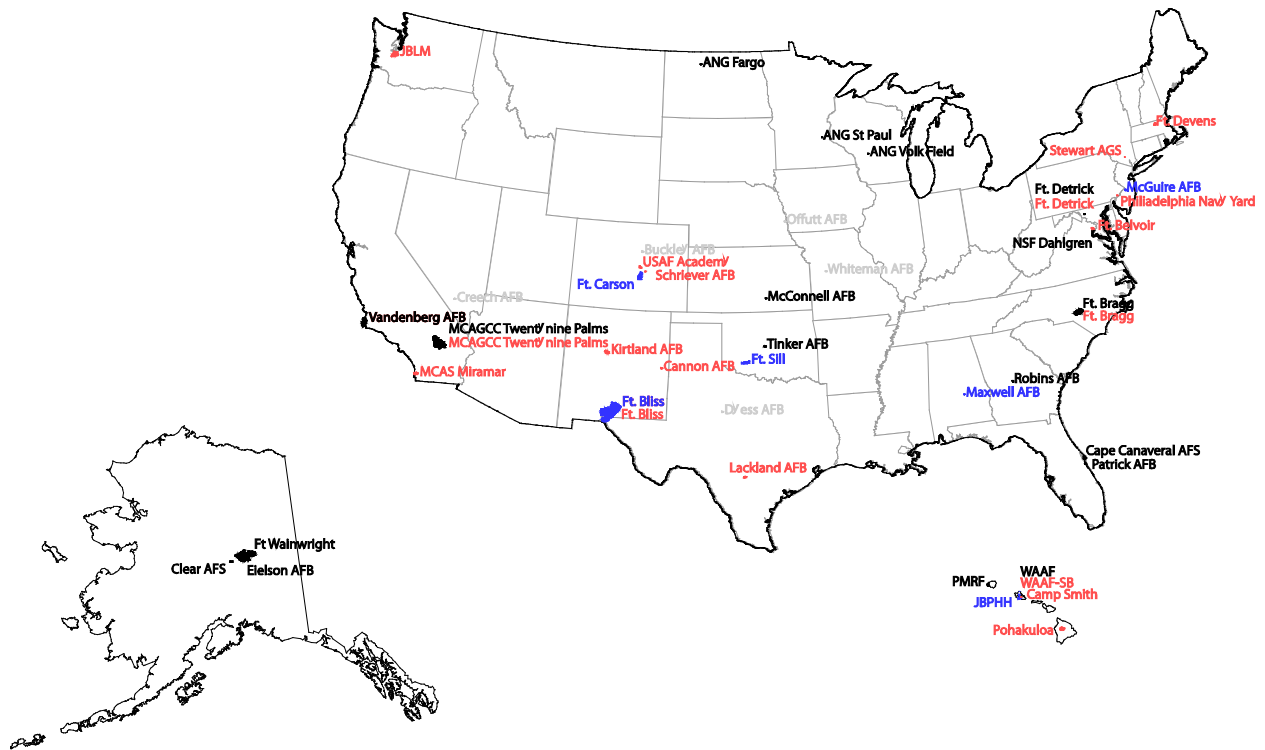

Microgrid efforts as of the end of FY 2011. **Black:** existing microgrids; **Blue:** efforts that are underway or demonstrations; **Red:** planned efforts or studies; **grey:** unable to determine microgrid status. Some locations have multiple efforts of the same type. Not pictured are the overseas microgrids at Kunsan AB and Osan AB, Korea.

Figure 2. Military microgrid locations.

3.1 DESCRIPTION AND CLASSIFICATION OF MICROGRID EFFORTS

There are a large number of potential criteria that could be applied to the classification of DoD microgrid efforts. These include design-related characteristics (electrical, control, and communications system design), performance characteristics (cost, maturity), and the microgrid goals (energy security, power quality, reduced carbon dioxide emissions). The two variables that have the greatest impact on the performance of a DoD installation microgrid are the degree of integration of the microgrid with the larger macrogrid and the technical complexity of the microgrid, particularly its choice of generation resources.

During grid-tied operation, it is the level of integration with the larger utility grid that will determine what utility services the microgrid can leverage to help offset the cost of resources on the installation. As will be described in Section 4.2, the faster a system can respond to requests from the grid operator the more value the microgrid provides to the larger utility grid with the financial benefits passed down to the installation.

During islanded operation, there are a number of key technical challenges which will drive the energy security benefits of the microgrid. Single backup generators that supply a given building or load typically run at low load factors leading to poor efficiency and maintenance concerns. Networking multiple generators allows generators to run more efficiently, but still relies on large amounts of diesel fuel storage to enable extended off-grid operation. The introduction of renewable generation, such as solar PV and wind, will reduce the amount of fuel storage required. At low penetrations (~20% and below) renewables can fairly easily be integrated onto a microgrid; however, the corresponding benefit is also quite modest. At higher penetrations, renewable generation potentially provides the greatest benefit, but its intermittency and low inertia (for solar PV) leads to significant technical challenges.

Figure 3 shows where existing DoD installation microgrids and current R&D efforts fall relative to their degree of grid integration and technical complexity.

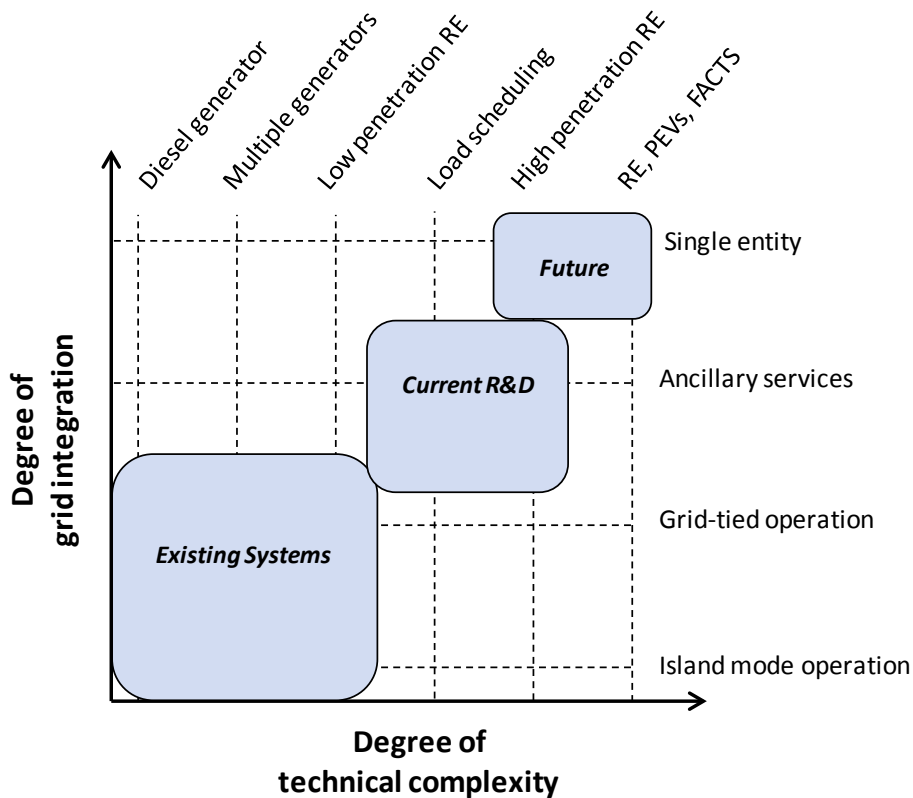
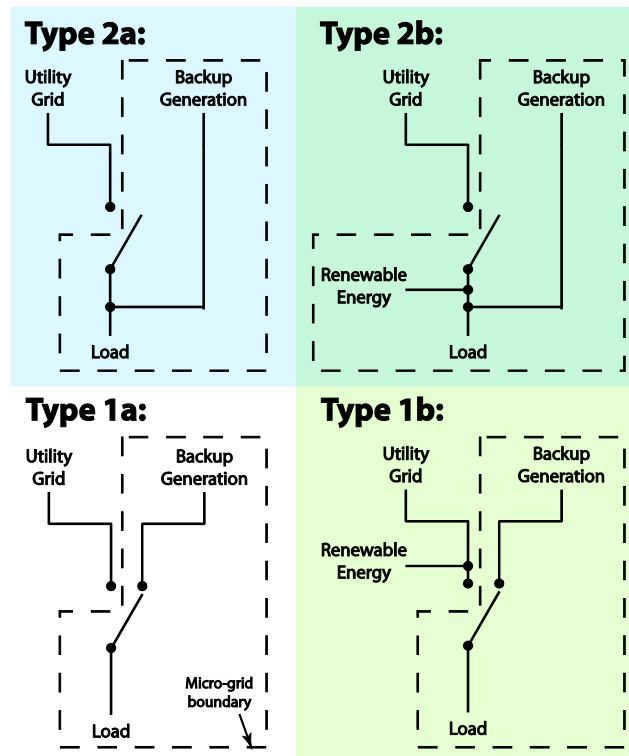

Figure 3. Key microgrid parameters.

Existing systems are primarily based on diesel generators with some systems being able to run in parallel with the local utility. No current DoD installation microgrids have the degree of integration with the utility grid necessary to participate in the ancillary services market. No current installation microgrids

can island with their intermittent renewable generation providing a large percentage of the installation’s power. There are, however, several R&D efforts that promise to demonstrate these capabilities within the next several years.

To simplify the presentation of the current DoD microgrid efforts, the two main attributes described in Figure 3 are simplified to two categories each. This leads to the common implementation of four main types of microgrids, which are termed Type 1a (stand-alone backup generation), Type 1b (stand-alone generation with grid-tied RE generation), Type 2a (grid-tied backup generation that can be islanded), and Type 2b (grid-tied backup generation with islandable RE generation) (Figure 4).



Notional schematics for how loads connect to the utility grid are shown for the four types of microgrids identified. Power sources are at the top of each panel and loads are at the bottom. Loads can connect through an either-or switch or with an on-off switch. The bottom half of the figure has systems that don’t interact with the utility grid vs. those that do. The left half of the figure has systems without renewable energy vs. those that do. Type 1a: stand-alone backup generation. Type 1b: stand-alone generation with grid-tied RE generation. Type 2a: grid-tied backup generation that can be islanded. Type 2b: grid-tied backup generation with islandable RE generation.

Figure 4. Types of microgrids.

Applying these distinguishing features against all the microgrid efforts for which information could be found results in the data shown in Figure 5. This figure categorizes the different microgrid efforts based on the four different types shown in Figure 4, their size (on a logarithmic scale), and their level of maturity: existing, underway or demo, or planned or study. At the beginning of FY 2012, the DoD's Environmental Security Technology Certification Program (ESTCP) initiated a new series of efforts on military microgrids; this figure does not show those efforts.

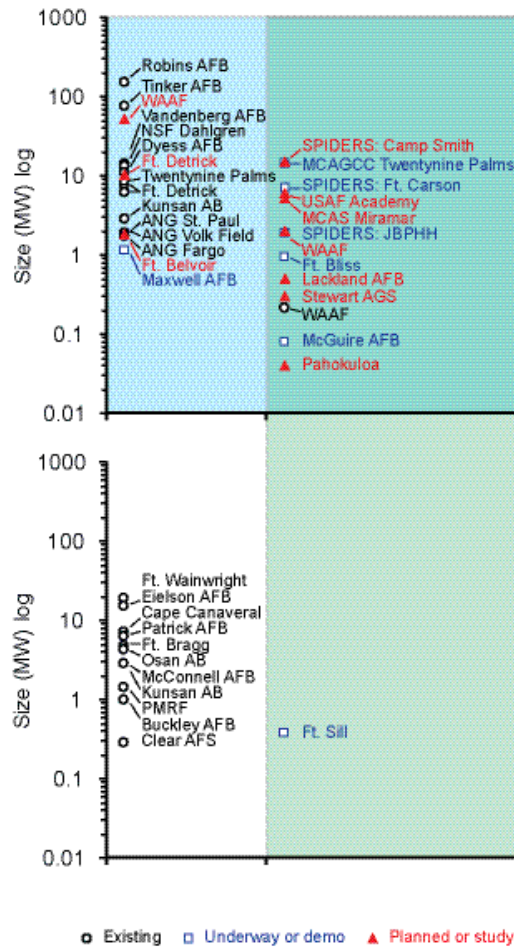

Using the classification shown in Figure 4 for the way in which microgrids interact with the utility grid and the existence of renewable energy resources, microgrids for which there was obtainable data are shown. Existing microgrids (black outlined circles) are primarily without RE generation resources while those that operate in parallel with the utility grid are typically larger systems (the scale is logarithmic). Microgrids that are underway or were demonstrations (blue outlined squares) are primarily able to operate in parallel with the utility grid and incorporate many more RE generation resources. Microgrids that are planned or were studies (red triangles) have all been intended for systems that interact with the utility grid. Not shown are the purported existing efforts at Offutt AFB, Creech AFB, and Whiteman AFB, for which contacts were unable to be reached.

Figure 5. Classification of existing DoD microgrid efforts by type, maturity, and size.

Almost none of the existing efforts include the integration of renewable generation onto a microgrid. The one exception is a smaller demonstration at Wheeler Army Airfield in Hawaii. The WAAF microgrid is the Honeywell-developed Smart Charging Micro-Grid (SCMG) developed for TARDEC. It is a compact ruggedized system of about 250 kW and includes significant stationary energy storage and a bidirectional vehicle to grid interface. The compact ruggedized nature of the SCMG closely resembles a tactical microgrid system. There are several ongoing efforts within the DoD that are looking to incorporate renewable generation onto an islandable installation microgrid, in particular the joint DoD/DOE SPIDERS (Smart Power Infrastructure Demonstration for Energy Reliability and Security) demonstrations at Joint Base Pearl Harbor Hickam (JBPHH) and Fort Carson, the microgrid project at Twentynine Palms in California, Ft. Bliss, and several of the FY 2012 ESTCP efforts described in Appendix B.

The distribution of microgrids that can and cannot operate in parallel with the local utility is approximately equivalent. The systems that cannot parallel generally consist of multiple generation assets that are collocated at either one or more substations. These require a static switchover from utility to installation power which, depending on the hardware used, may allow for very brief paralleling to achieve synchronization enabling a soft transition. It is likely that there are some additional installations that fall into this category that were not able to be captured during this survey. With the increasing availability of gensets with paralleling capability, it is likely that more installations with generators dedicated to single loads will begin moving towards this architecture.

The systems that can parallel with the utility can be further classified based on the forcing function that was the impetus for the development of the microgrid. These objectives include:

Financial benefit: There are several installations that have tried in recent years to take advantage of the rate structure from their local utility by using local generation sources for financial benefit. One of the more significant efforts is at Ft. Bragg, North Carolina and involved the installation of 6 MW of diesel generators to perform peak-shaving. In addition, ANG Fargo, ANG St. Paul, and ANG Volk Field have installed backup diesel generators and enlisted these systems in demand-response programs. In these cases, the financial benefits from the demand-response program have more than paid for the lease of the generators. None of the installations listed currently participate in the more time-sensitive ancillary services markets such as spinning reserve or frequency regulation. A greater degree of automation and control will be required to participate in those markets.

Critical Loads: The National Interagency Biodefense Campus at Ft. Detrick in Maryland is an example of a sustained critical load that requires a very high reliability power supply. In order to provide this high reliability, a microgrid system was installed at Ft. Detrick that supplies electricity with 99.999% reliability. An example of a short-term critical load would include the launch facility at Vandenberg AFB. Due to mission criticality, the base is required during heavy lift operations to provide two independent sources of power: on-base diesel generation and utility power. The generation assets on-base need to be running in parallel with the utility and need to be fully loaded, so the excess power (several MWs) is dissipated through a large resistive load.

Intermittent Electrical Service: Because of the fairly remote location of many DoD installations, it is not uncommon for an installation to be near the end of a utility feeder. This makes it more likely that the installation will experience more frequent power interrupts. NSF Dahlgren in Dahlgren, Virginia and MCAGCC Twentynine Palms in Twentynine Palms, California have responded to this situation by building, over the course of a number of years, substantial on-base generation capabilities. Both installations can operate these assets in a grid-tied manner. For Kunsan AFB in Kunsan, Korea, the local utility (KEPCO) requires 48 hours of downtime per year for the substation that feeds the base, in order to provide preventative maintenance. A system of eight MEP-12 generators (6 MW total) can feed the entire base during this annually planned outage and half can also operate in parallel with the utility.

Utility Operated Assets: Both Tinker AFB in Oklahoma and Robins AFB in Georgia have utility-operated natural gas-fired peaker plants located on-base. These plants can be islanded and provide the base with energy security during a grid outage. Wheeler Army Airfield and the Hawaii Electric Company are in the early phases of investigating a similar arrangement.

3.2 DETAILED DESCRIPTION OF SEVERAL EFFORTS

Representative examples of different existing microgrid approaches have been chosen in this section to be described in more detail (all efforts shown in Figure 5 are described briefly in Appendix A). Three examples of different implementations of Type 2a microgrids, systems that include conventional generation with the capability of operating grid-tied, are provided. NSF Dahlgren has an extensive network of diesel generators that was installed due to poor reliability in the local utility grid, and which participates in a demand-response program through a third part aggregator. Fort Detrick has two microgrids that were designed to provide highly reliable power to critical assets. Tinker and Robins AFBs have utility-operated natural gas peaker plants located on base that can be islanded and provide energy security if the local grid were to go down.

In addition, three examples are provided of installations that are currently funded to develop Type 2b microgrids, systems that include renewable generation with the ability to operate grid-tied. Twentynine Palms has an existing microgrid which includes a 7.2 MW cogeneration plant, and is in the process of incorporating several MWs of existing PV onto their microgrid. The SPIDERS program has two microgrids currently under development. The first phase is a microgrid at JBPHH that includes a small quantity of PV and wind with conventional diesel generators. The second phase SPIDERS microgrid at Ft. Carson will be more advanced, including high penetrations of PV (2 MW) and the planned integration of plug-in electric vehicles. The Ft. Bliss microgrid includes solar PV, diesel generators, and lead acid batteries. During grid-tied operation, the Ft. Bliss microgrid will be able to peak-shave using the generator and battery. In general, the Type 2a microgrids require more advanced controls and automation to balance and optimize renewable and conventional generation with energy storage.

3.2.1 NSF Dahlgren

Naval Support Facility (NSF) Dahlgren, part of Naval Support Activity (NSA) South Potomac, is an installation within the Naval District Washington (NDW). NDW is developing a phased approach to increase their energy efficiency and energy security capabilities. In implementing this plan, the first phase was to install and network together meters for electricity, natural gas, and hot water. The work started about two years ago with now approximately 200-300 devices at NSF Dahlgren, NSF Indian Head, and Washington Navy Yard. They are in the process of finishing the other 18 fencelines in NDW.

The second phase is to develop concept of operations (CONOPS) so that energy management can be automated and scaled where it makes sense. There will be a tremendous increase in sensor data, but human operators will still play a critical role, making clear and consistent CONOPS an important aspect.

The third phase will be to allow the selective demand-response, load-shedding, or islanding of areas of an installation. NAVFAC (Naval Facilities Engineering Command) Washington has procedures that govern how transfer switches operate for switching between generation sources at a substation that may impose temporary obstacles. At the moment, some switching at substations requires people to be on-site, but since the procedures are there to increase safety, it may be possible implement this system with cameras instead.

To implement this three-phased approach, NDW has started by taking existing systems and networking them together in a cyber-secure manner. This has been made easier by the fact that after September 2001, the Navy created a Public Safety Network (PSNet) that is used for Navy Public Safety operations in the continental United States (CONUS) area. The existence of this system meant that the smart meters can be integrated into an existing infrastructure.

At NSF Dahlgren, there has been a microgrid system for many years. Originally, the microgrid was implemented because of service reliability problems with the commercial utility (Dominion Virginia Power [DVP]). A cost analysis a decade ago showed that the lost revenue from power outages more than paid for the lease of generators from the NAVFAC Mobile Utilities Support Equipment program. The generators installed were in addition to the critical load generators that were required for specific Navy working capital programs. In implementing the microgrid, NSF Dahlgren has put in a Supervisory Control and Data Acquisition (SCADA) system as well as switching systems at substations, which are collocated with the generators. The generators are at the substations, not at individual buildings, allowing power to be used throughout the base, depending on the configuration of the substations. The microgrid is operated in two modes: to provide backup power to the facility if the utility grid goes down, and to operate in parallel with the utility grid to reduce load on the utility grid. The generators cannot back-feed power into the utility grid (in addition to the financial and safety complexities that this would introduce, there are technical aspects that would need to be solved).

Currently, all of their backup generation capacity is diesel-powered because, at the time of implementation, that was the option that made the most financial sense. As renewable energy and energy storage come down in price, NAVFAC and NDW would consider adding these to the microgrid since the

infrastructure already exists. NAVFAC and NDW are interested in both the financial and energy security aspects and stated that one has to complement the other.

The cost calculations for the microgrid have also included different ways to interact with the utility market. The rate structure that the base formerly operated on made it economically attractive to use their generation capacity in an active effort to reduce peaks in energy usage through peak-shaving. This rate structure has since changed, and they are currently enrolled in a demand-response program, where they can, and do, curtail power usage or start their own generators to reduce apparent demand. NSF Dahlgren currently has 14 MW of generation capacity enrolled in the demand-response program through a third-party, and they were called on several times last year to perform. The payments from the demand-response program cover the costs of the generator leases, showing that energy security can be enhanced in a cost-neutral way (dependent on which part of the country the installation is located).

The cost equation at NSF Dahlgren could change, as Dominion Virginia Power is currently upgrading the single 34.5 kV feeder to the base so that there will be an additional 115 kV feeder line. If the base no longer loses power regularly and the availability of the demand-response program changes, the lease economics for the generators could change.

3.2.2 Fort Detrick

There are two existing microgrids at Fort Detrick: at the signal corps area and at the central utility plant. The signal corps microgrid has existed since 1975 and is dedicated to and collocated with the mission, which is in a fenced area. Even though this is mission-dedicated capacity, Fort Detrick has started operating in a demand-response program through a third party, using a quarter of their 8 MW generation capacity (the peak mission load is around 2.5 MW), while still allowing $n-1^2$ redundancy with Fort Detrick's generator sets. In the summer, the base frequently operates the microgrid in an islanded configuration due to frequent outages and poor power quality from the local utility. The mission requirements specify a 30-day supply of diesel fuel.

The second microgrid is also mission-specific. Privately owned and developed through an enhanced use lease, it provides steam, chilled water, and conditioned electric power to medical and research missions at the National Interagency Biodefense Campus. This microgrid provides 99.999% electrical reliability so that its normal operation can transition seamlessly to backup generation. The capacity is being expanded from 6–7 MW up to 16–17 MW, but due to the mission criticality, it is not available for backup power for the rest of the base or for cost-saving measures through demand-response or ancillary service markets. The base pays 21¢/kWh for electricity from this microgrid, as compared to 8¢/kWh for electricity from the utility.

² $n-1$ is a resiliency criterion that requires continued availability of the power network if any single asset were to fail.

Fort Detrick has also commissioned a study to look at a wider microgrid deployment on the installation, including the ability to link backup generator requirements in a way that is more reliable and cost-effective. The study recommended a 10.3 MW diesel-powered generator microgrid design which would allow long-term backup capability, whereas the individual building generators are designed for short-term operation. (Refueling trips for the 50+ building generators becomes an issue with tanks that have limited individual capacity.)

Fort Detrick also has ESTCP funding for an energy storage installation by SATCON and is investigating the possibility of a 10 MW solar PPA. Fort Detrick is an Army Net Zero installation.

Challenges:

Discussions with Fort Detrick also brought up that communications requirements could pose a challenge: the *supervisory control and data acquisition* (SCADA) equipment that they installed (Schneider Electric, Square D Power Logic) has a certificate of worthiness that is now required to connect systems to the installation local area network. Equipment without that certificate cannot be connected, leading to potential challenges if the smart meters were purchased before all networking questions were resolved.

3.2.3 Tinker AFB and Robins AFB

Tinker AFB and Robins AFB have on-site combustion gas turbines, owned and operated by their respective local utility companies, which provide power to the installations in the event of a power outage. Each base was approached independently by the utility companies when they were looking for a location to site peaking power plants. The generators were installed and paid for by the utility companies, with the base providing the land.

Tinker AFB has two utility owned-and-operated 40 MW generators in one of the substations that operate routinely in the summer, but provide backup, islandable power for the base in the event that the grid goes down. The base has first rights to the power and, in the event of a grid power blackout, the generators can be used to blackstart the utility grid (blackstart is the ability to go from a shutdown condition to an operating condition without the utility grid – other generating units can then restart and synchronize to the unit that has restarted). The blackstart or islanding operation has yet to be operationally tested at Tinker. The 40 MW generators have about three days of backup JP-8 fuel for power generation. They began operating in 1988 and are on a second 15-year contract period. In addition, the utility at Tinker AFB wants to build a 250 kW solar array. The building targeted is on the 15 kV distribution system and would also be islandable, with the rest of the 80 MW backup power.

Robins AFB also has an on-site combustion turbine plant, theirs consisting of two 80 MW generators. Operated by Georgia Power, the Robins plant is a peaking power plant during normal operation but, like the Tinker AFB power plant, can be islanded upon loss of grid power (this capability was tested three years ago at Robins). Normally the generators' gas turbines run on natural gas, but they use a 1.3 million gallon diesel tank for backup (corresponding to about 18 days of operational capacity).

There is also a 3 MW generator used to blackstart the grid if both larger generators go down. In practice, though, the generators would most likely never operate in an islanded mode, as they tie into the Georgia power 115 kV primary line and feed loads off the installation as well. Restarting the grid and service decisions would be made by the utility company, but given the proximity of the base to the generation, Robins AFB is likely the first customer restored to power.

3.2.4 MCAGCC Twentynine Palms

Marine Corps Air Ground Combat Center (MCAGCC) Twentynine Palms has an existing microgrid that operates daily, powered by a 7.2 MW CHP plant fueled by natural gas with diesel backup. It normally operates 24 hours a day/seven days a week, generating power in parallel with the local utility, Southern California Edison (SCE), to provide electricity and heat to the main power loop of the installation. It is directly tied in to one of the substations and has the ability to operate in an islanded mode, should the main feed for the installation go down. There is a requirement for seven days of backup diesel fuel, with diesel storage at the cogeneration plant and elsewhere on the base. During the course of this study, many changes to the MCAGCC Twentynine Palms microgrid have been in process. ESTCP has funded several General Electric (GE) efforts at Twentynine Palms, including the installation of smart microgrid controls and the future installation of an energy storage system. The description provided here was current as of February 2012.

Switchover to islanded operation is currently performed manually at the control room of the CHP plant, but in the next couple of months (as of February 2012) it will transition to automatic switching at the substation. While operating in islanded mode, switches and breakers allow the main power loop to shed loads if demand exceeds generation, with additional switches currently being added.

There is also 3.2 MW of solar PV generation capacity operational on the base, distributed among approximately 30 individual building-level arrays and a larger 1.2 MW field that ties directly into the CHP plant substation. 1.3 MW of additional PV is installed and awaiting SCE interconnection approval. The PV arrays can feed the CHP plant in the event of power loss from SCE and has been operationally tested in early 2012 with load shedding plans implemented. There are more than 60 new switches to change power flows through the base and more than 140 buildings with Energy Management and Control System (EMCS) power management systems. Future plans call for more buildings with EMCS and tighter integration of those systems with the controls at the CHP plant. MCAGCC Twentynine Palms currently has about 80% of their buildings metered, which gives them insight into more than 75% of all electricity use. They are also adding natural gas, MBTU meters for hot water, and MBTU meters for cooling. Those meters will then tie back into the EMCS and the base-wide public works network.

The main feed from SCE is a single 34.5 kV line, but the installation is outgrowing the ability of that line to provide power, especially in the summer and with the significant expansion of the installation that is underway. SCE is installing redundant feeder lines to Twentynine Palms, with dual 115 kV lines, which will improve electrical service in the whole area, but that is still underway (with planned finish date of January 2013), with some permitting issues that have extended the timeline repeatedly. Upon completion, the installation will own the infrastructure at the substation.

In addition to the solar PV upgrade, the plan calls for installation of a second CHP plant (it will be a dual 4.6 MW turbine for a final output of 9.2 MW powered by natural gas with propane backup so that there will be more diversity of backup fuel), more PV (5.5 MW), the ability to control the power factor of the generation resources with a capacitor bank, and a large-scale battery back-up. There has been a 0.5 MW fuel cell in progress for several years, but it is not yet operational.

Also, GE is conducting a smart grid demonstration at four buildings to show controllability of five generators (range 20–150 kW) as part of a multiphase effort. Unfortunately, due to permitting problems, they cannot currently be used in load-shedding applications, but only in an emergency if the installation needs to operate in an islanded mode. Other efforts include improving the power factor control with capacitor banks; better control of supplies, loads, and load-shedding; and installation of a battery backup system.

The entire installation of Twentynine Palms consists of over 900 square miles of land area located in the high Mojave Desert of California. As such, the base is an attractive location for the large-scale implementation of renewable resources and is exploring the possibility of exporting excess power. This excess power would be provided through a power purchase agreement (PPA) to other Navy and Marine Corps facilities in southern California. It will take several years to gain the appropriate approvals but, if successful, will help to meet Federal and Navy renewable mandates.

Challenges:

California has more stringent requirements than other states in terms of emissions standards. Assembly Bill 32 (AB32) was signed into law in 2006 and aims to reduce greenhouse gas (GHG) emissions and cap them at 1990 levels by 2020 [4]. The law limits the total metric tons of GHG that can be produced, but there is no allowance for growth. This is a challenge since many buildings have their own generators, new buildings are being built, and many new buildings will have backup power requirements. The installation of the CHP cogeneration plant allowed Twentynine Palms to drastically cut the use of boilers that were high emissions and low efficiency, but this unfortunately did not count towards the California Air Resources Board (CARB) requirements for CO₂ emissions reductions. There are holdups with the second CHP plant because of permitting considerations, but the base is pushing for a permanent waiver to AB32; it is currently scheduled for completion in January 2013.

Communication with the substations has posed challenges because of cyber-security concerns. The original plan was to use a wireless communication system for the base EMCS. To help resolve these concerns, MCAGCC Twentynine Palms is in the process of running fiber optic connections to the substations, but at the moment they do not have communications support. This lack of communications control has delayed the smart grid demonstration that GE has been working on. This communications infrastructure will also be used for developing EMCS controls. The protocols running over the fiber optic lines will have cyber-security controls to allow the meters and EMCS systems to tie in to smart grid controls.

3.2.5 SPIDERS

The Smart Power Infrastructure Demonstration for Energy Reliability and Security (SPIDERS) JCTD is a multiphased joint effort to develop microgrids in a cyber-secure manner. SPIDERS is a collaboration between several of the DOE Laboratories with several organizations within the DoD and is led by the U.S. Army Corps of Engineers. The effort is subdivided into three phases, with build-out efforts at Joint Base Pearl Harbor Hickam (JBPHH) (Phase 1), Fort Carson (Phase 2), and Camp Smith (Phase 3). The goal is to deploy or apply technology over legacy systems, looking at the technical feasibility as well as the business case and value proposition. Phases 2 and 3 are adding elements of cyber security to allow situational awareness and the ability to coordinate power demands with the utility provider.

The first phase includes traditional generation coupled with small-scale renewable generation (solar and wind) to island a water treatment plant at JBPHH. The preliminary design for the microgrid includes two diesel generators supplying a maximum of 2.4 MW, 50 kW of vertical-axis wind turbine generation, and the potential to incorporate a hydrogen storage system and small scale solar PV. The total critical load that is being serviced is approximately 650 kW. The contract for Phase 1 was awarded in November 2011 to Burns & McDonnell Engineering Company. A key component of this phase is to work with the Navy accreditation process, the DoD Information Assurance Certification and Accreditation Process (DIACAP) [5], and platform IT to ensure that equipment developed for the microgrid architecture is able to be used with all network infrastructures. If desired, all services have the opportunity to implement the same architecture by leveraging the Navy's accreditation approvals for the SmartGrid networks and system through the DoD's reciprocity memo [6].

The Request for Proposals (RFP) for the second phase at Fort Carson was released in January 2012 as a two-stage RFP, with first-phase responders down-selected to submit full proposals in the second phase. The Fort Carson microgrid will incorporate existing generation resources with large-scale renewable (solar) resources and battery backup (supplied in electric vehicles). The load that will be targeted for the Fort Carson demonstration will be a 2–3 MW critical load. The solar PV available on-base is approximately 2 MW. Key components of this phase are to include cyber-security considerations (a major stumbling block for other implemented microgrid efforts) and the design of a microgrid with very high penetration of renewable generation.

The third phase of the SPIDERS program will be a microgrid at Camp Smith, Hawaii that is capable of operating the entire installation independently from the local utility in a cyber-secure manner. The precise details for this phase are still being formulated, but the current plan is to do a microgrid for the entire campus (~15 MW) with diesel generators, solar PV, and energy storage. The plan is dependent on FY 2013 funds, so is not yet formalized. There have been serious power quality and power outage issues at Camp Smith over the last six months.

3.2.6 Fort Bliss

The Fort Bliss microgrid is an ESTCP funded development that is in-process as of February 2012. The project aims to construct a microgrid that will be integrated into the Dining Facility of the Battalion Combat Team-1 (BCT-1) complex at Ft. Bliss, Texas and is being executed by Lockheed Martin. The total peak power of the microgrid will be approximately 600 kW, with the expectation that it will be a scalable solution.

The goals of the Ft. Bliss microgrid are to reduce green house gas emissions, lower operating costs, and enhance the energy security of the installation. The microgrid consists of existing diesel backup generators (250 kW), an existing PV array (100 kW), and a new lead-acid battery (300 kW/60 kWh). Advanced controls will be integrated into both the existing PV inverter and the diesel generator to allow for islanded operation and advanced performance optimization.

The architecture of the Ft. Bliss microgrid is designed to be flexible with distributed control at each distributed energy resource (DER) interfacing onto a common integration bus. The distributed controllers interface with a centralized microgrid controller that optimizes the dispatching of DER resources, aggregates and displays system performance, and could act as a single gateway to the utility EMS.

The utility rate structure at Ft. Bliss includes both a significant demand charge based on the peak demand (kW) during each monthly period and very different on and off peak energy charges during the summer months. By shaving peak demand and shifting demand to off peak time periods, the Ft. Bliss microgrid will aim to reduce overall operational cost of the system. Both the battery and the diesel generator will participate in the peak shaving activity, although the generator will be limited due to emissions requirements.

Peak-shaving requires a knowledge of the installations energy demand, but does not necessarily require a direct tie to the utility EMS. Still, this is an important initial demonstration of the dual usage of energy-storage devices, both to provide additional energy security while off-grid and cost savings during grid-tied operation.

The installation is also looking at an ESPC project (112 kW at a range facility, 112 kW at another range, 1 MW on post).

3.3 SUMMARY

Energy security is not a new problem for DoD fixed-site installations. Critical loads have historically been required to have a backup energy source to sustain operations if the grid were to go down. This strategy has resulted in installations that have a large number of smaller generators dispersed around the installation typically tied to the low voltage supply for individual buildings. While this system is simple to implement and provides a fairly robust solution to intermittent short duration power outages, it is not a system that is optimized to provide longer duration energy security.

The use of generation assets that can supply a larger portion of an installation, typically through a medium voltage connection, and can be controlled and operated through a base-wide energy management system, has a number of benefits. These include the ability to provide power more efficiently, the potential to provide reliable power more cost effectively, and reduced maintenance requirements (fewer large generators as opposed to many small ones). If facilities are going to be required to island for greater than 72 hours, then fuel storage will likely need to be centralized. The problem of dispensing fuel then becomes a logistics burden for large installations that could have over 50 critical loads.

As DoD installations move towards centrally controlled generation assets tied to a medium voltage distribution system, the opportunity exists to operate these systems in a grid-tied manner. The added complexity required to operate on-base generation assets in parallel with the larger grid will depend strongly on the requirements of, and opportunities to work with, the local utility. Several installations, including NSF Dahlgren and Ft. Detrick, have determined that this added complexity is worthwhile either for increased reliability or to gain financial benefit through utility rate structures. These installations participate in emergency demand-response programs whereby the installation receives a monthly incentive based on the capacity of the assets enrolled in the program. Emergency demand-response programs typically involve a human-in-the-loop and require the installation to respond within an hour to a request from the utility.

Microgrids at both Ft. Bragg and Ft. Bliss have more automated systems that are used for peak shaving. The Ft. Bliss microgrid will use *a priori* knowledge of the bases' electricity cost structure and real-time energy usage data to shave loads using energy storage devices and generators. The Ft. Bragg microgrid uses diesel generation assets to peak-shave both to reduce monthly system peaks and for economic dispatch based on day-ahead hourly rates from the local utility.

As will be discussed in Section 4.3.2, the DoD is operating under a number of renewable energy mandates. In order to meet these goals, the military has started looking at the significant deployment of renewable generation, particularly solar PV on select installations. Currently all of the renewable generation systems on an installation must be disabled when that installation loses grid power. There are, however, several installations that are in the process of implementing islandable, renewable generation systems, including Ft. Bliss, Twentynine Palms, and the SPIDERS microgrids at Ft. Carson and JBPHH. Through this ongoing research, a better understanding of the cost-effectiveness of integrating renewable generation onto installation microgrids will be achieved.

The integration of high penetrations of renewable generation onto an installation microgrid will require a higher degree of sophistication, including advanced controls and energy storage systems. It is possible, however, that much of the additional cost of these more advanced systems can be offset by participating in the ancillary services market, thereby using these technologies for financial benefit during grid-tied operation. A project starting at Air Force Base Los Angeles in FY12 will be the first demonstration of assets on a DoD installation participating in the ancillary services market. This project is not planned to be a microgrid demonstration, and instead focuses on the integration of plug-in electric vehicles on DoD installations.

There is no standard approach to solving the problem of energy security. Each base has different existing infrastructure and mission requirements. But while there is no one-size-fits-all solution, the natural progression is towards more integrated systems that allow for greater flexibility and potentially longer off-grid operation. Additional research and, most importantly, site demonstrations will be required to fully understand the economic and technical tradeoffs in these complex systems.

4. ENVIRONMENT

The location of a military installation influences the options available for energy generation sources, the options available for interaction with the local utility, the characteristics of the local electricity infrastructure, and the regulatory environment. In addition to the installation itself, the service it is a part of, the load profile of the installation, and the local energy manager play a large role in the successful implementation of microgrids that increase energy security. Renewable generation sources are discussed in Section 4.1, characteristics of the domestic utility grid and market options are discussed in Section 4.2, and characteristics of installations themselves are discussed in Section 4.3.

4.1 LOCATION-DEPENDENT CHARACTERISTICS (RESOURCES AND WEATHER)

The location of an installation has a strong influence on the cost equation for renewable generation. It is well known, for example, that the resources available for solar energy production are greatest in the Southwestern part of the United States, while the greatest wind resources are available in the plains states, Texas, and off of the eastern seaboard. The maps in Figures 6 and 7 show the distribution of solar and wind resources across the U.S., respectively.

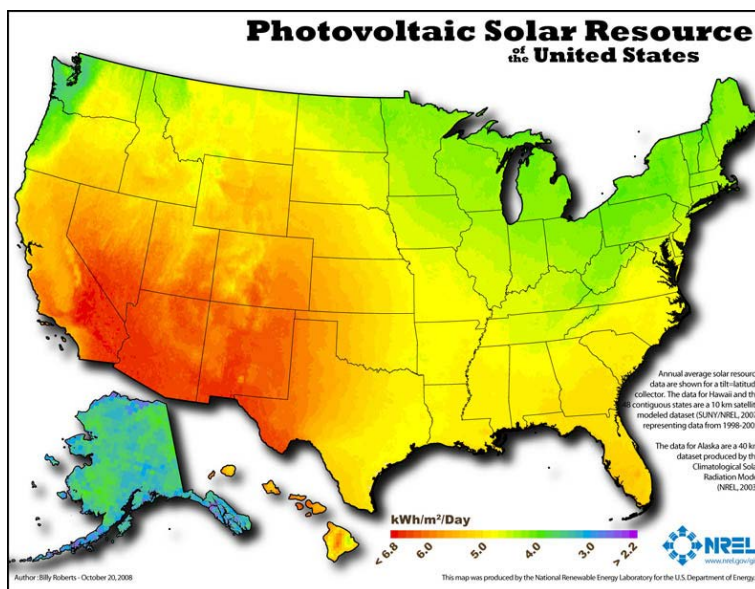

Figure 6. Solar PV resources in the U.S.

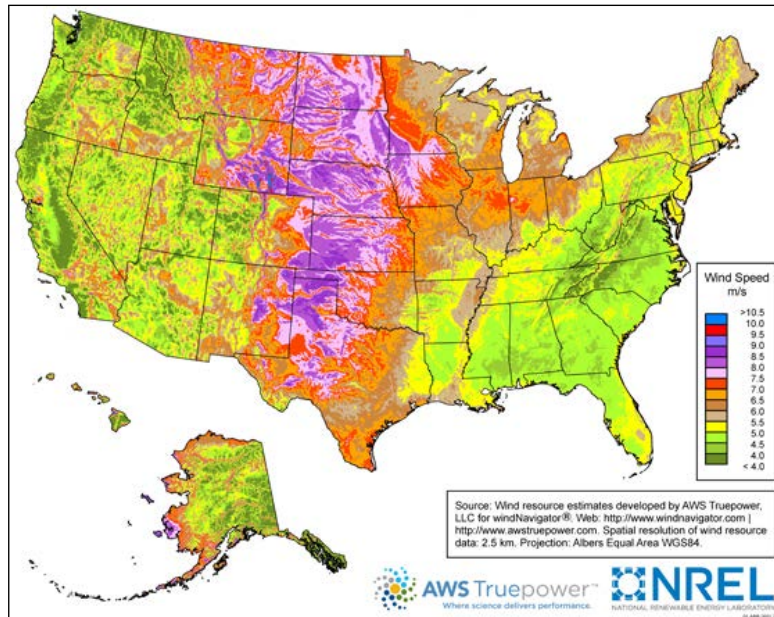

Figure 7. Wind resources in the U.S.

While the average distribution of natural resources across the U.S. is well known, it is only one of the measurements of resource viability that is important for microgrid design. Depending on what kind of utility pricing structure the installation operates under, the financial benefit from renewable generation is dependent on the total performance of that resource over the entire year (the total kWh of energy produced) or on the peak production during times of peak load (for installations with real-time pricing). The benefit for energy security will need to be considered based, not on the average conditions, but on the resource availability during the least favorable time of the year.

For example, the ability of photovoltaic generation to extend the length of time that an installation can operate in an islanded manner depends not on average values of solar availability, but on how much power is produced during the time when the installation must be islanded. This can be highly variable in the short term, so the length of islanding time required for that installation impacts the role renewable resources can have in meeting that requirement. The longer the length of time an installation must island, the less variation there is in power output from the renewable generation, and the more it can factor into the energy security strategy. The variability of renewable resources and their impact on energy security will be discussed in more detail in Section 5.3.4 with an emphasis on the impact that solar PV can play in meeting the energy security goals.

There are other, nonintermittent, resources that could both provide energy security for an installation and help meet renewable mandates. Biomass, geothermal generation, and landfill gas systems are examples of dispatchable renewable resources that could fill this role. However, most of the efforts

within the DoD are focused on the integration of solar PV due to its increasing cost effectiveness, relative ease of installation, and general availability. As such, solar PV is the primary renewable resource examined in this study. Future work can, and will, incorporate other renewable resources as well as the impact of cogeneration.

4.2 DOMESTIC ELECTRIC GRID CHARACTERISTICS

Across the United States there exists a wide variety of electricity markets. Some of those markets provide mechanisms by which microgrid capabilities could be used to provide services to the utility grid that provide payback to the installation, helping to pay for the energy security provided by the microgrid. To highlight these options, this section provides a brief overview, from a DoD-relevant perspective, of the characteristics of the larger electric grid that are important in determining the openness of the local utility market, the revenue streams available, and the electricity pricing structures that exist. For a more in depth overview of the electric grid and the effects of deregulation, suggested reading includes “The Future of the Electric Grid,” an interdisciplinary MIT study, or “A Primer on Electric Utilities, Deregulation, and Restructuring of the U.S. Electricity Markets” by Mike Warrick [7, 8].

4.2.1 A Brief Overview of the Electric Grid

The domestic electric grid can be subdivided into three main components; the power generation plants that produce electricity, the transmission infrastructure that moves the electricity across long distances to load centers, and the local distribution system that provides power to end users. This system is shown graphically in Figure 8.

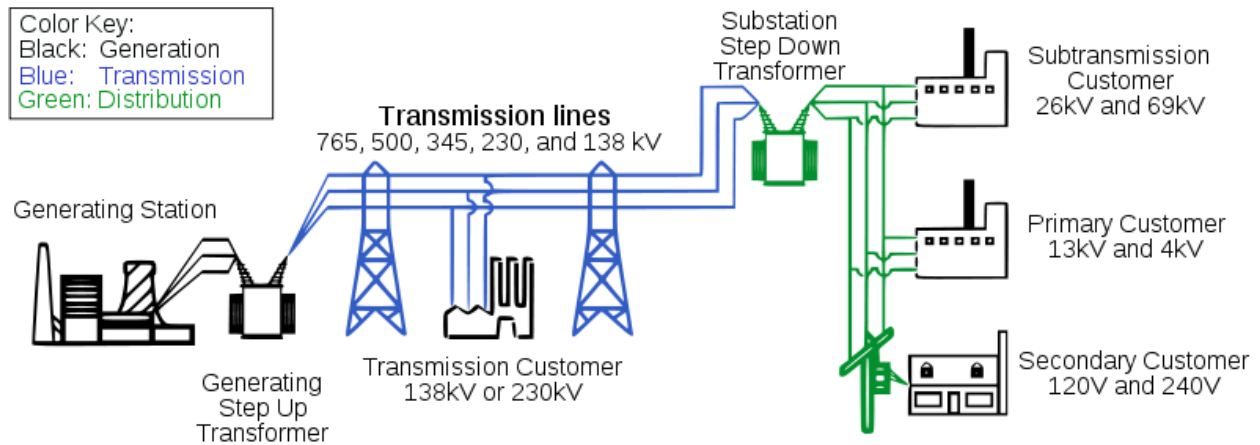
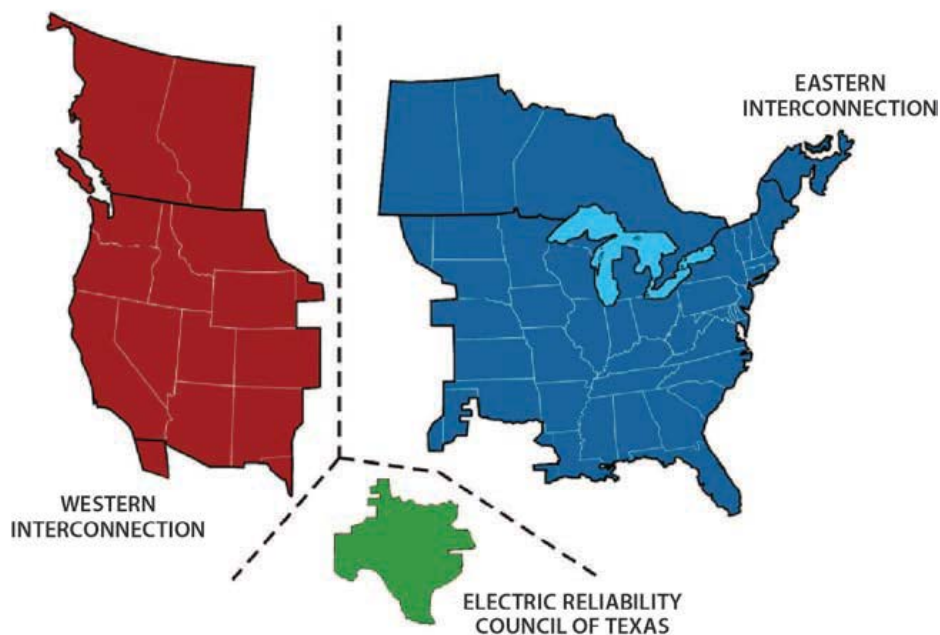

Figure 8. Major components of the electric grid.

A large majority of the generation plants in the U.S. are fossil fuel powered, although there has been a steady increase in renewable generation facilities in recent years. Generation plants are typically very large to take advantage of economies of scale, and are located far from major load centers such as cities. Voltage is stepped up to higher voltages when leaving the plant in order to reduce losses during transmission.

The transmission infrastructure moves power across long distances, including state lines from generating plants to customers. From a physical standpoint, the continental North American transmission system is divided into several distinct, disconnected regions as illustrated in Figure 9. These systems are not synchronized; therefore, there are no AC interconnections between the three regions, only a few high voltage DC interconnects exist.



Physical separation of the North American electricity grid is generally thought of as having three main regions – the Western Interconnection, the Electric Reliability Council of Texas, and the Eastern Interconnection – with no AC connections between them.

Figure 9. Subdivision of the North American grid.

The distribution system converts the power from higher transmission level voltages to lower voltages that can be used by end customers. The distribution provider is also responsible for interacting with end customers including negotiating and setting rates.

4.2.2 Deregulation and the Electricity Markets

Traditionally utilities were vertically integrated enterprises that owned and operated generation, transmission, and distribution assets as well as providing service to captive end customers. Because utilities were a monopoly, their rates were negotiated with regulators and priced to reflect the utilities' costs and an agreed upon rate of return. Starting in the late 1990s, the power industry in the United States began to deregulate. In regions of the country where deregulation has occurred, the formerly vertically integrated utility monopoly has transformed into a competitive market where a large number of enterprises compete to provide power.

Traditionally it is the role of a balancing authority to ensure that loads and generation resources are matched over a given control area, thus maintaining a stable frequency for the utility system. There are currently more than 100 different balancing authorities in the U.S. and Canada, as shown in Figure 10.

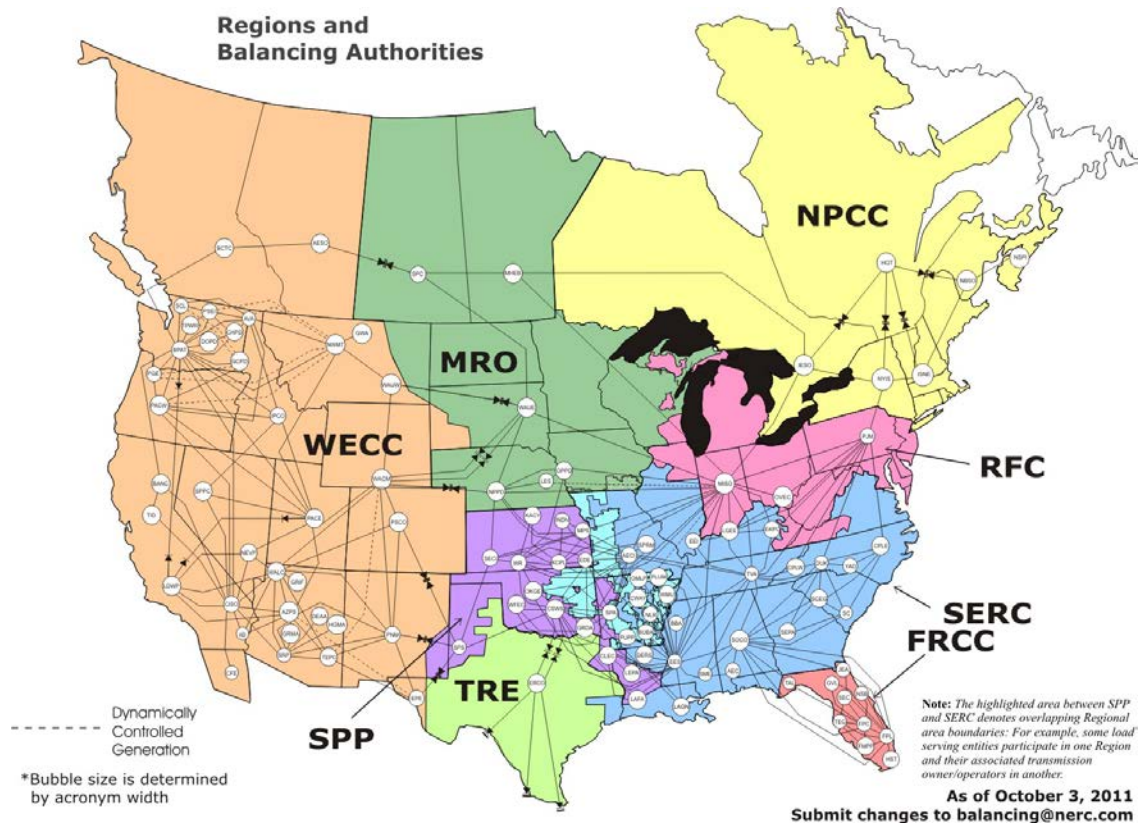

Balancing authorities across the continent are shown in white bubbles, and NERC regional entities are shown by different colored regions. Physical breaks between the regions shown in Figure 9 are shown here with black double-headed arrows [9].

Figure 10. Balancing authorities and NERC regional entities.

Independent Systems Operators (ISOs) or Regional Transmission Organizations (RTOs) are larger balancing authorities that may act across state lines. In certain deregulated markets these entities also act as wholesale electricity markets to provide nondiscriminatory access to transmission, to help with regional planning, and to enable competition in the wholesale electricity market. As competition in wholesale markets has led to the greatest diversity of market options, the location of all CONUS fixed installation military installations are shown overlaid on top of the map of ISOs and RTOs (Figure 11).

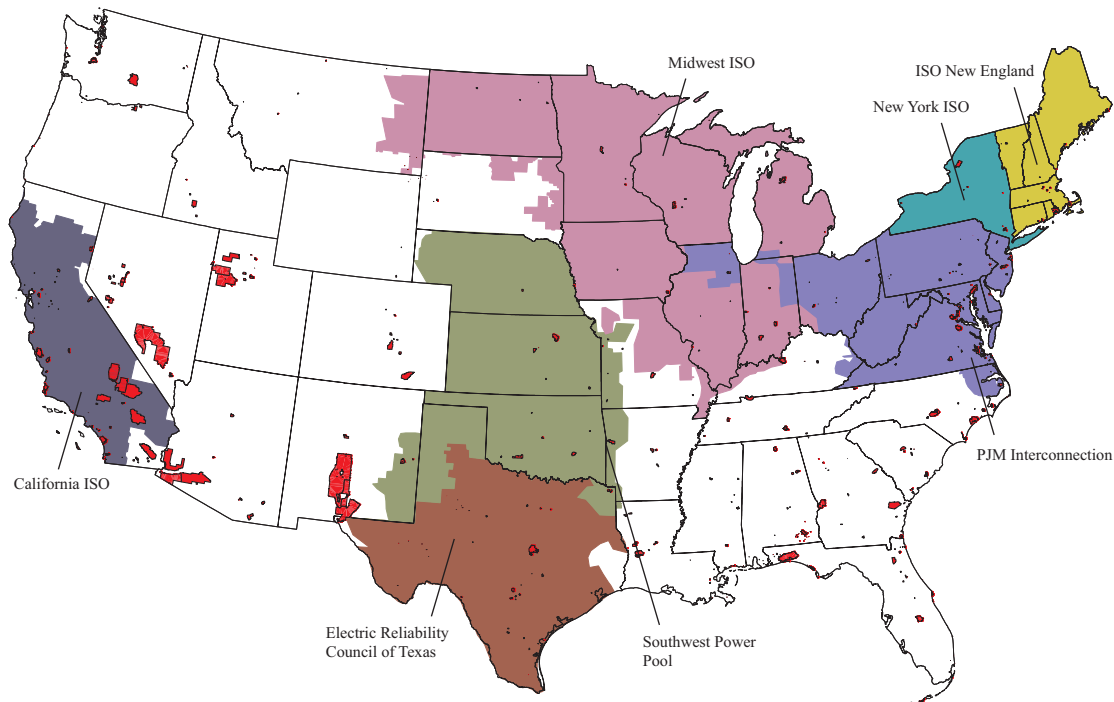

The seven ISOs and RTOs in the U.S. are shown in color with the locations of all military installations superimposed in red.

Figure 11. ISO/RTO boundaries and military installations.

Currently two-thirds of all consumers are served by wholesale markets, with the remaining served by a combination of vertically integrated utility companies, municipally owned utilities, federally owned utilities, or cooperatives. Regardless of market structure, the general strategies that all balancing authorities follow for normal (noncontingency) operation include: unit commitment, forward scheduling, load following, and frequency regulation. Figure 12 [10] illustrates the time scale for these strategies. Unit commitment and day-ahead scheduling are determined days and, in some cases, up to three years in advance through a bidding process. Load scheduling is determined on the same day and is usually obtained through economic dispatch. Frequency regulation has a short required response time, ranging from seconds to a minute.

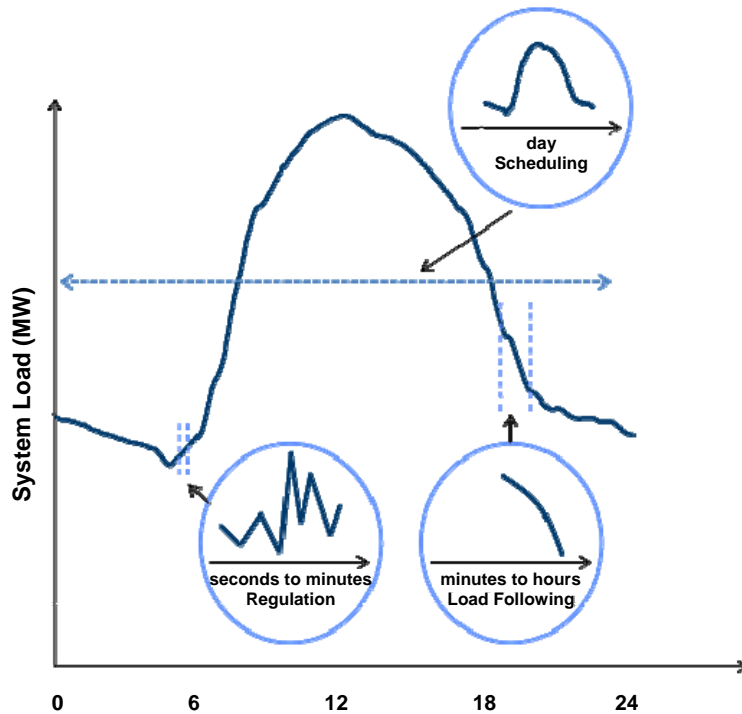
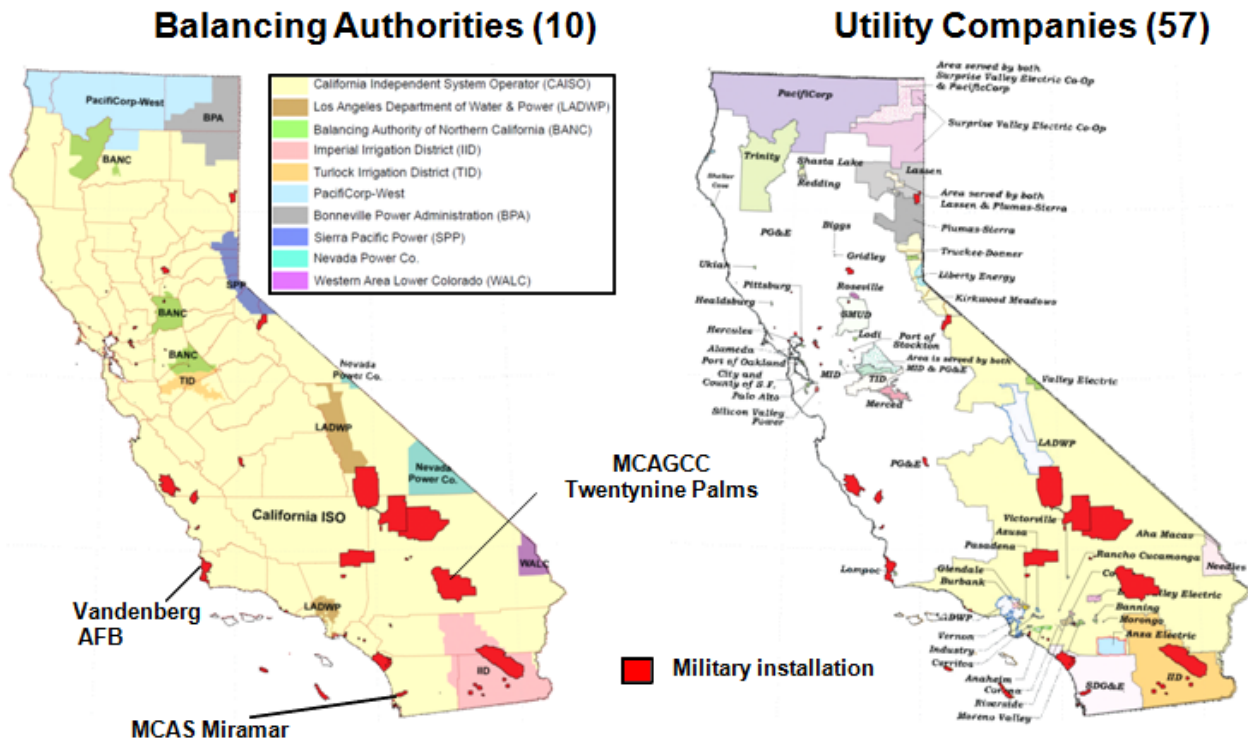

Figure 12. Generation and load balance.

4.2.3 Electricity Prices and Ancillary Services

The wide variety of stakeholders in the electricity market complicates the determination of options available for military installations in different regions, in different markets, and with different utility providers. Particularly within the wholesale markets, a wide range of pricing options exist that depend on the grid infrastructure, the generation resources online at a given moment, and demand requirements. Utilities also have distinct rate structures for specific types of customers and different pricing alternatives.

Even within a state's boundaries there are often a large number of balancing authorities and utility companies. Energy market choices based solely on the state where the installation is located would almost always be too broad; finer granularity has a significant effect. As an example, the breakdown of balancing authorities and utilities with the location of all DoD installations in California are shown in Figure 13.



The left panel shows the different control areas for the 10 balancing authorities in California with military installations overlaid in red. Highlighted in black text are installations that have or are implementing microgrids. The right panel shows the 57 different utility companies and the areas in which they operate.

Figure 13. Balancing authorities, utilities, and DoD installations in California.

Further confusing the determination of electricity prices, even within a given ISO or RTO there is no single price for electricity or services. Due to congestion in the transmission system, it is more costly to supply power to certain locations within a service area. Locational Marginal Prices (LMPs) are provided at 295 different nodes within the PJM Interconnection RTO; the Midwest ISO (MISO) reports LMPs at 1964 different locations.

The price of electricity for any consumer, including DoD installations, consists of energy usage, transmission, and distribution costs. Energy usage costs depend on the mix of generation resources (coal, natural gas, nuclear, wind, etc.) employed in the local area and vary depending on the time of day and year. Utilities typically dispatch their generating plants with the lowest operating cost first and reserve more costly, and often faster-responding, generation assets to respond to shorter-term fluctuations in demand.

Transmission and distribution assets are scaled to meet the peak demand on a system, and as such it is common for large consumers to pay a transmission cost based upon their peak demand. This peak can be the peak demand over the course of an entire calendar year, the peak demand in a given month, or the peak demand on the day of the total system peak demand.

It is therefore common for a large electricity customer, such as a DoD installation, to have both an energy charge based on the kWh of energy used over the billing period and a separate demand charge based on peak kW. The energy charge can either be a negotiated flat rate or, for certain installations within an open market region, a real-time price that updates on an hourly basis. The peak demand charge can either be a direct charge or it can be tied to the energy usage charge where the kWh rate is based on the peak kW demand over a defined time period.

To protect the system and to ensure reliable generation and load balancing during contingency events, such as a sudden loss of power generation or the failure of a transmission line, balancing authorities also acquire operating reserves for contingency operations. In the areas of the country with open energy markets, bases can enlist their on-base assets in these programs for financial gain.

Contingency operations fall into the following categories: spinning, non-spinning, and replacement reserves. Spinning reserves are unloaded generation assets that are online, that are synchronized to the grid, and that can respond immediately to an event. The North American Electric Reliability Corporation's Disturbance Control Standard (NERC's DCS) requires that spinning reserves reach full output within 10 minutes. Non-spinning reserves are generation sources that do not have to be synchronized to the grid and therefore do not need to respond immediately; however, non-spinning reserves still have to reach full output within 10 minutes as required by the NERC's DCS. Some balancing authorities also have replacement reserves, which have a longer response time of 30 to 60 minutes. Replacement reserves are used to replace spinning and non-spinning reserves.

During normal operation, the system operator must continuously match supply and demand to ensure the frequency of grid is maintained very close to the nominal 60 Hz. They do this by directing a very small portion of the overall grid generation capacity, roughly 1%, to follow minute-to-minute commands to increase or decrease output. This service is known as frequency regulation and, as shown in Figure 14, is the highest priced of the ancillary services.

Figure 15 [11] outlines the different categories of operating reserves for normal and contingency operations along with the resources' required response time and duration of operation. Regulation, spinning, non-spinning, and replacement reserves make up what is known as ancillary services. Services that require fast response time are more valuable to the market than those that respond slowly; the breakdown of day-ahead average price of ancillary services in California ISO in 2011 is shown in Figure 14. The prices are similar in the Midwest ISO [12].

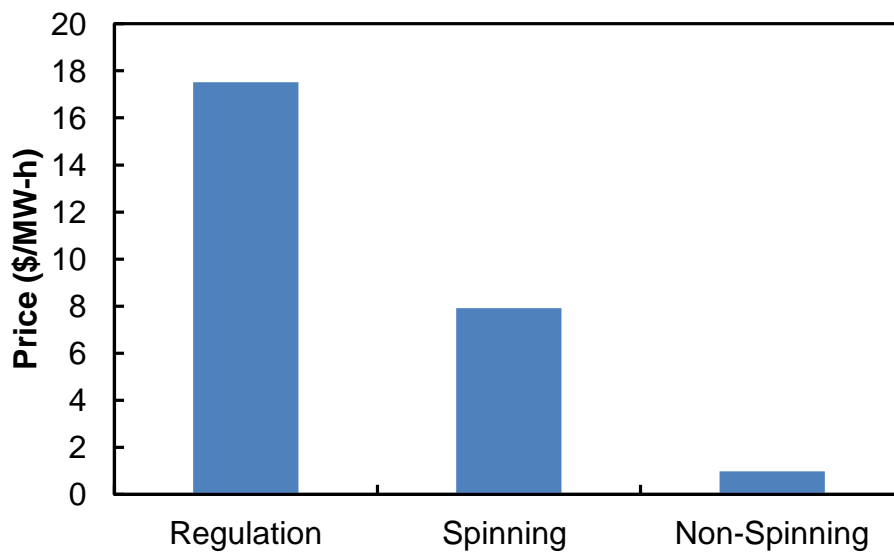

Figure 14. Ancillary services pricing for California ISO, 2011.

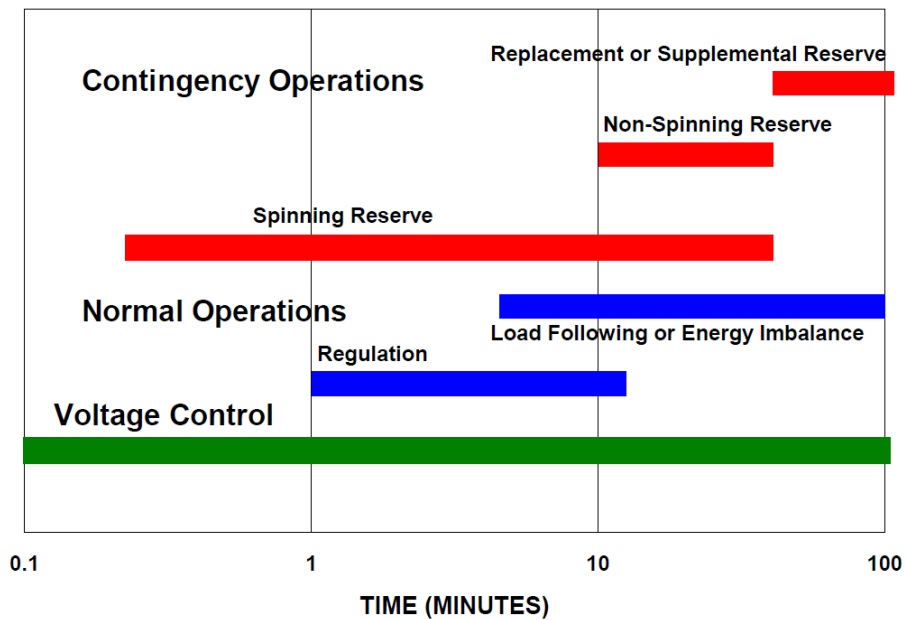
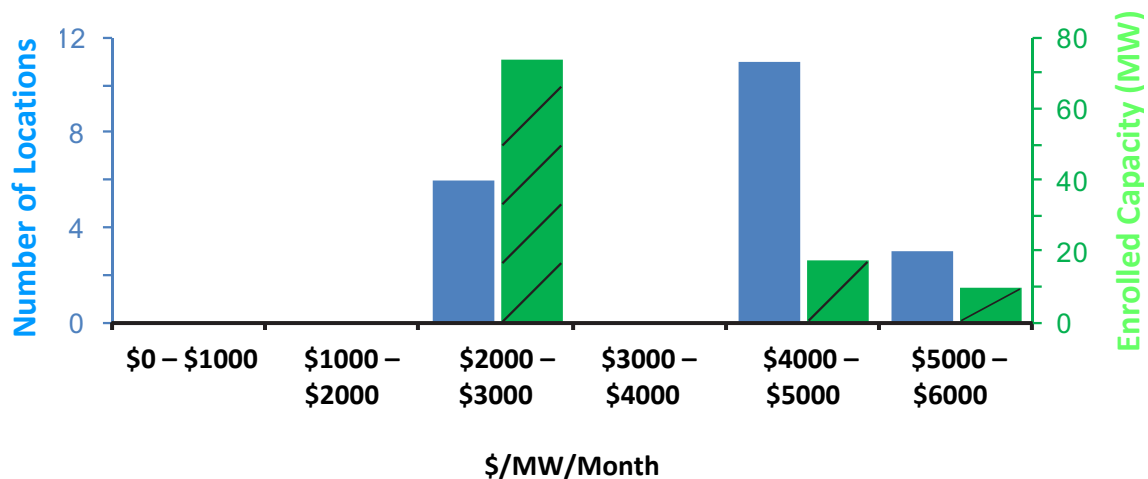

Figure 15. Required response time and duration of operating reserves.

Currently, frequency regulation resources, typically generators, have automatic generation control (AGC) which can be automatically dispatched by the balancing authorities control center operator. Recently, FERC order 755 requires power operators to compensate owners of frequency regulation sources based on performance and capacity [13]. Order 755 requires RTOs and ISOs to account for frequency regulation resources' accuracy in following the AGC dispatch signal. Although this order does not explicitly favor one technology over another, it is clear that it favors a more responsive system that will be able to follow the AGC dispatch signal more accurately. Energy storage devices, such as batteries, should benefit from this new regulation, as they typically have better fine control over power output than other assets that typically bid into the market, such as natural gas peaker plants.

As an alternative to adding expensive short-term generation assets to the network, market operators have also developed a mechanism to shed large quantities of load for abbreviated time periods. By decreasing demand on the transmission and distribution infrastructure, congestion can also be alleviated potentially preventing brownouts or blackouts. These programs are known as demand-response programs and are available either through aggregators or directly to large customers, including DoD installations. When enlisting in a demand-response program, an installation will promise to drop a certain amount of load (in MWs) upon a signal from the local market operator or utility. The installation is then provided with a financial credit on its electricity bill based on the quantity of assets enrolled.

A number of installations participate in the program by using dispatchable distributed energy resources on-base to curtail the installation's total power draw. The Defense Logistics Agency (DLA) helps installations enroll in demand-response programs, and currently 60+ government installations participate through the DLA. Data from 2009 for the number of locations, revenue, and enrolled capacity for locations in the PJM Interconnection are shown in Figure 16.



Demand-response rates for locations in the PJM Interconnection with a breakdown of the number of locations in blue (left vertical axis and columns) and total enrolled capacity in MW in hatched green (right vertical axis and columns).

Figure 16. Payback for DLA demand-response programs in PJM (2009).

Figure 17 summarizes the relative value of the different ancillary services and demand-response programs. Faster response times are more valuable to the system and, therefore, those services are priced higher.

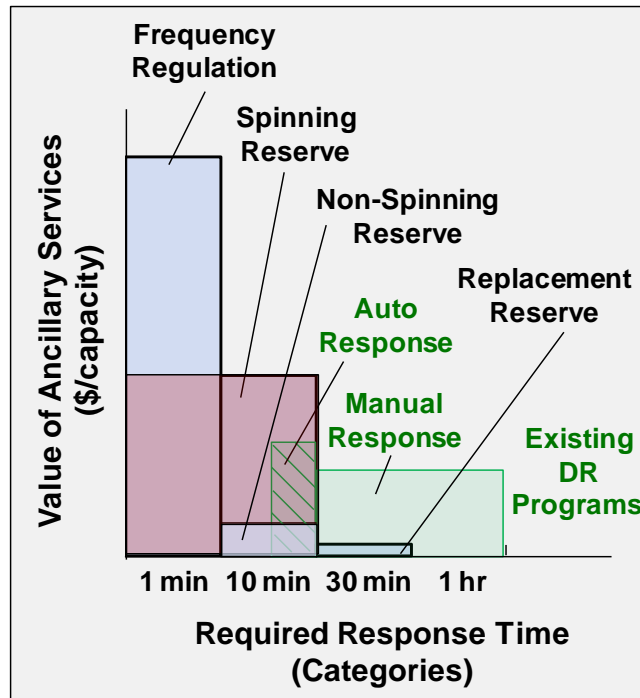

Figure 17. Faster response time results in greater benefits in the ancillary services market.

There are a number of different assets on an installation that could participate in either the demand-response or ancillary service markets. Diesel generators can participate in demand-response programs and potentially in replacement and non-spinning reserve programs, assuming they meet state and federal emission requirements. Energy storage systems on bases are well suited to enlist in spinning reserve and frequency regulation markets; controllable loads on an installation can participate in demand-response programs and, in some ISOs, can bid into the spinning reserve market as well. The spinning reserve market is particularly well suited towards load-shedding applications due to the need for fast, but short duration, response.

The analysis conducted in Section 5 focuses primarily on real-time pricing and demand-response programs, as those are the mechanisms currently leveraged by bases to pay for on-base assets. As installation microgrids become more integrated with utility systems, other programs may become more

advantageous for a given installation. In general, the location of an installation within a wholesale electricity market will give the installation more flexibility to tailor the rate structure towards the microgrid architecture. This is a complex task, and it would be advantageous if this expertise lay in a central resource that could assist installation energy managers make informed decisions.

4.3 DEPARTMENT OF DEFENSE INSTALLATION CHARACTERISTICS

Characteristics of DoD installations that are important for determining an optimal microgrid architecture include the installation's load profile, the availability of land, the existing infrastructure on the installation, and the availability of skilled personnel.

4.3.1 Installation Load Characteristics

From an energy security standpoint, the load profile of the installation in general, and the load profile of critical assets [14] in particular, strongly influence the cost effectiveness of renewable generation assets. In situations where the load profile is well correlated to the renewable energy generation resource, large quantities of costly energy storage may not be required. Also, when renewable generation is closely correlated to base load, it increases the viability of renewable generation for providing energy security. Conventional generation assets will be sized to make up the difference between demand and renewable generation; therefore, a higher degree of correlation means fewer conventional generation assets will be required on a microgrid. Section 5.3.2 provides a more detailed discussion of the important characteristics of an installation's load profile.

The determination of which assets are considered critical and will be incorporated onto a microgrid is an important aspect in establishing the extent of the system. The difficulty is that the definition of what is considered critical may heavily depend on the duration and type of event that occurs. For instance, a gymnasium would not normally be considered a critical asset, but in response to a natural disaster, the gymnasium could be used for triage or for housing displaced families and could be considered a critical asset. More advanced microgrids will ideally include the flexibility to distribute power across the installation depending on need and circumstances.

4.3.2 Renewable Generation Viability

Many laws and executive orders have been passed in the last decade that mandate changes in the sources of and the way that the Federal government uses energy. These mandates are shown graphically in Figure 18. In addition, specific departments within the military have set higher goals, with the Secretary of the Navy setting the goals to reduce petroleum use by 50% by 2015, to have 50% of total energy consumption coming from alternative sources by 2020, and to have 50% of installations be net-zero by 2020, among others.

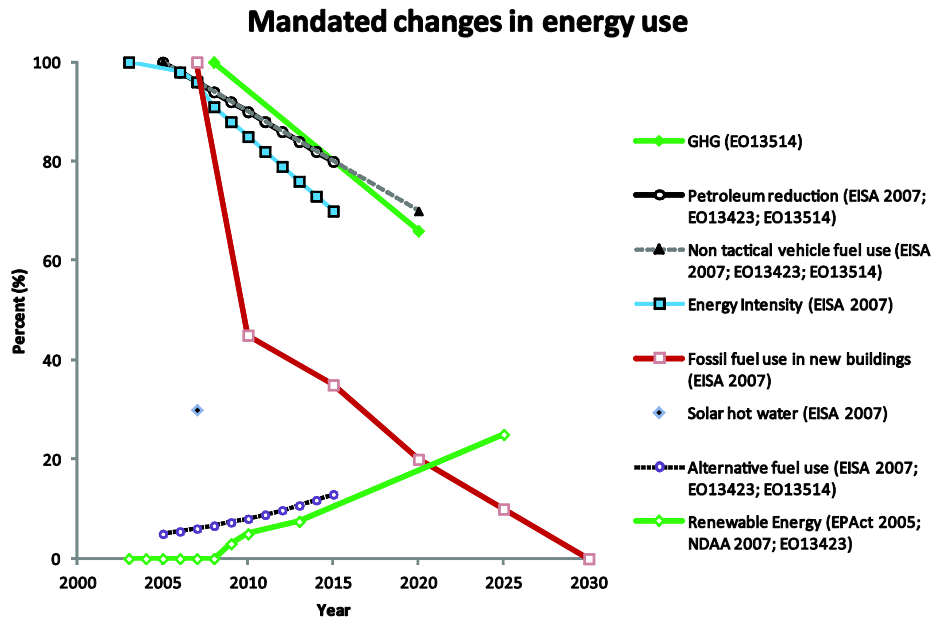

Changes in energy use are shown as a percentage of their value from the year in which the mandate sets as the base year. All changes are absolute, with the exception of alternative fuel use, which is designated to increase 10% per year from 2005. For this chart, the base value that is shown is 5%, although that is notional. EISA 2007: Energy Independence and Security Act of 2007; EPAct 2005: Energy Policy Act of 2005; NDAA 2007: National Defense Authorization Act for FY2007.

Figure 18. Laws and Executive Orders mandating changes in energy generation and use.

Many installations have made progress towards meeting the federal or service-specific goals, but the task gets more complex as initial simple fixes are completed. The availability of renewable resources (typically solar, wind, and geothermal) will affect the choices for the different services and installations as to the method by which they meet the mandate of 25% renewable energy by 2025 [15].

It is likely that installations in areas of the country that are particularly attractive from a resource viability and electricity price standpoint may be candidates for large-scale renewable generation. A recently completed analysis on solar PV production on Mojave Desert installations [16] identified high quality land with 7,000 MW of potential generation capacity at five installations. For installations that will be installing large-scale renewable generation, likely either through a power purchase agreement or other 3rd party mechanism, it is important that adequate pre-planning is done to allow a portion of that asset to be used for energy security. Currently, all commercial PV systems are designed with anti-islanding provisions – when the grid goes down, they are disabled. This is primarily for the safety of personnel working on the utility grid. In order for the PV system to be available on a microgrid, the controllers for the solar inverters will need to be able to operate islanded, the PV system will need to be

sited in a location accessible to the microgrid, and contractual provisions will need to be included that gives the base first right to the power produced by the PV system.

4.3.3 Installation Resources

Potentially the single most critical determinant in the success of a microgrid project is the presence of skilled and motivated electrical technicians and engineers to design, operate, and maintain the system. In the current funding environment, many installations are seeing a significant reduction in these important positions where staffing is already thin. In addition, the skill sets required to operate these complex systems are in high demand in the commercial industry, making it more difficult to hire and retain the right people. There has been a move in recent years to privatize these operations on domestic DoD installations [17]. Privatization could help in the hiring and retention of the right workers, but could make other aspects of installing energy security microgrids more difficult. The right financial incentives will need to be designed that impel the private organization to build systems that provide energy security in addition to being cost effective.

The existing installation infrastructure is not directly considered in cost-benefit trades described in Section 5, but it is important in determining the appropriate microgrid design for a given installation. The expense of implementing a microgrid will depend significantly on what of the existing electrical distribution system, generation assets, metering, and command and control system can be leveraged. If an entirely new energy management system is required, if the distribution topology needs to be seriously reconfigured, or if the existing generation assets cannot be used in a microgrid, those costs could drive the choice of microgrid architecture.

4.3.4 Cyber Security and Metering

The wide range in monitoring capability across different installations, as mentioned in Section 3.2.1, is due to the availability of cyber-secure infrastructure, with the Navy farthest along in obtaining data from distributed smart meters. The Navy developed a system, Public Safety Network (PSNet), after 9/11 to support First Responders, Emergency Management, and the monitoring of critical infrastructure. The Navy plans to interface facility metering data to this network to allow for centralized data collection and analysis. Naval District Washington (NDW) has also developed smart metering and communication nodes which have gone through the required certification process and are being installed in several installations within NDW.

There are several other efforts within the DoD to develop cyber secure metering systems for fixed site installations, most notably the SPIDERS microgrid projects. It is critically important that a baseline set of security requirements are established for installation microgrids, and a collection of hardware is certified for use in these applications. The services continue to install additional meters, and additional guidance to the services on metering will be forthcoming this spring [18].

This page intentionally left blank.

5. MODELING AND ANALYSIS

A cost-benefit analysis at the system level aids in evaluating the costs associated with increased energy security of existing and future microgrid architectures for domestic DoD installations. This is an initial investigation into the economics and technical tradeoffs of implementing microgrids on domestic DoD installations. These should be considered preliminary results only. Only a small set of the potential architectures are explored, and then at only a very high level. The results presented in this section are meant to be illustrative of major cost-benefit trades in determining the optimal microgrid architecture. Additional rigorous analysis coupled with testbed demonstrations will be required to fully understand the additional costs of energy security and the preferred implementation strategy.

5.1 DESCRIPTION OF MICROGRID ARCHITECTURES

Figure 19 depicts four types of microgrid architectures distinguished by its generation resources and level of integration with the utility grid. This classification is explained in greater detail in Section 3.1. A cost-benefit analysis is performed for Type 1a, Type 2a, and Type 2b architectures. In the Type 1b architecture, the renewable generation is not able to island and therefore does not improve the energy security of the installation. The renewable generation would just be used to offset electricity provided by the local utility. Therefore, Type 1b architecture is not included in this cost-benefit analysis. The following describes those microgrid architectures analyzed in this study.

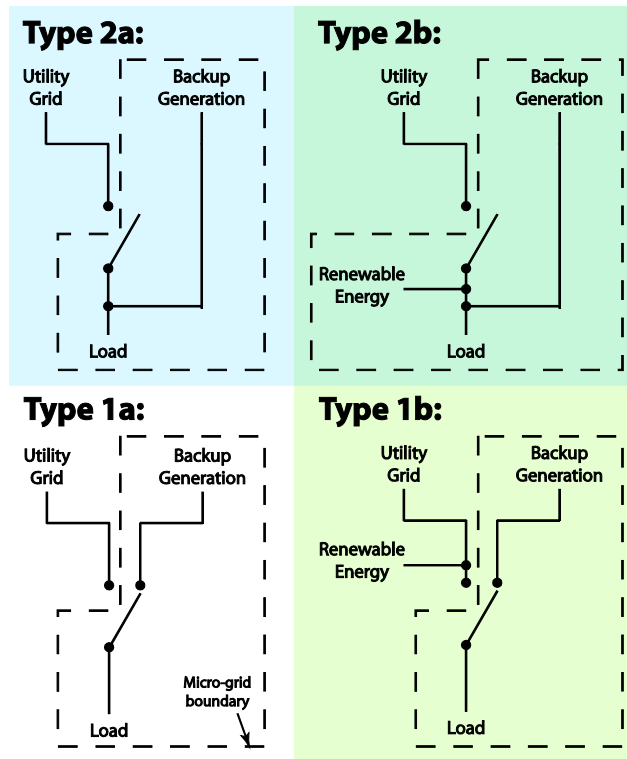

Figure 19. Microgrid architectures.

Type 1a: Backup generators, not grid interactive

The Type 1a architecture mirrors that of the existing emergency backup system for most domestic DoD installations. At present, generators are typically used to provide backup power during emergency events. Generators' emission regulations and allowed annual duration of operation, set by the Environmental Protection Agency (EPA) at the federal level and by state and local authorities, vary depending on their intent and purposes. Appendix C discusses the emission regulations schedule set by the EPA. This analysis assumes that the generators in this architecture comply with Tier 2 emission regulations matching the current EPA rules for large, greater than 560 kW (751 hp), stationary emergency generators.

Throughout this study, it is assumed that multiple generators are able to parallel and load share. Many older generators on DoD installations do not currently have the ability to load share and can only operate as stand-alone units. The goal of this analysis is to contrast different microgrid architectures and therefore assumes that the generators have been outfitted with intelligent controls that allow the generators to participate in the microgrid.

The number of generators selected to run at any given time has a total power capacity to meet the installation's hourly power demand plus an additional capacity that matches 10% of the installation's maximum hourly power demand. This additional 10% is the spinning reserve required to absorb short-term fluctuations in demand and also to meet standard (n-1) reliability criteria. This in effect forces the generators to run at a lower load factor and therefore a slightly reduced efficiency. This is still a much higher load factor than would be expected for stand-alone generators that cannot power share.

Type 2a: Backup generators, grid interactive

In the Type 2a architecture, generators are still the only power generation sources during emergency events similar to Type 1a architecture. In contrast to the system in the Type 1a architecture, where the generators are not tied to the utility grid and are turned on only during a truly emergency event, the system in the Type 2a architecture integrates with the utility grid. The system's integration with the utility grid allows the owner of the generators to enroll the generation assets in a demand-response program to gain monetary payback to help offset the initial and operational costs of the generators. The demand-response program considered in this report is an emergency demand-response program from permitted generation, i.e., the installation drops its overall load by turning on its backup generators.

The frequency in which the generators operate depends on the demand-response programs. The EPA along with state and local authorities have set more stringent emission standards for generators enrolled in demand-response programs, requiring these generators to satisfy Tier 4 emission level in the near future [19], incurring an extra cost for either a replacement or for converting existing Tier 2 generators to Tier 4 generators.

Currently, there is only one manufacturer (Caterpillar) that markets Tier 4 generators. In addition, most DoD installations already have a set of generators, and a conversion to Tier 4 emission levels likely means implementing after-treatment strategies to reduce emission levels of existing Tier 2 generators to meet requirements of Tier 4 generators instead of replacing the generators entirely. For the purpose of this study, it is assumed that this conversion is required if a generator is enrolled in any demand-response program, and the cost of the conversion and additional switchgear required to parallel with the utility system is 40%³ of the initial cost of a Tier 2 generator.

Type 2b – Low penetration of PV: backup generators and PV, grid interactive

The Type 2b architecture builds upon the framework of Type 2a architecture and adds on renewable generation to the portfolio of power generation resources. For this analysis, only one renewable technology, solar PV, is considered. In the low penetration case, the capacity of solar PV is set at 25% of the base load of the system.

³ This value is estimated based on private communications with Cummins's and Caterpillar sale engineers.

In addition to electricity from solar PV, generators provide the additional power to meet the installation's hourly power demand. Similar to the other two previous architectures, there is a spinning reserve requirement for the generators. The generators are set to run at only 90% of their maximum power capacity. Due to the relatively small quantity of PV, it is assumed that the 10% spinning reserve from the generators can still absorb any mismatches in supply and demand. Fuel for the generators is the only source of energy storage on the microgrid modeled in this case. The size for the power capacity of the renewable source is selected such that, due to the low penetration of PV, no additional energy storage is required in this system.

Type 2b – High penetration of PV: backup generators and PV, grid interactive, with battery

Similar to the previous Type 2b case study, this architecture includes both generators with 10% spinning reserve and solar PV. The solar PV penetration for this architecture is increased from 25% in the previous case to 75% in this case. Due to the higher level of solar PV penetration in this architecture, a bank of batteries that can store 15 minutes of the maximum output from the solar PV system is installed to smooth out any short time scale second-to-second or minute-to-minute fluctuation of electricity generation from solar PV. The battery energy storage addresses two issues: (1) to provide stability by helping absorb short-term fluctuation in supply and demand, and (2) to reduce the cycling of the generators, thus prolonging their lifetime.

This study assumes that a distributed energy storage with 15 minutes of potential solar energy is sufficient in order to evaluate the first level cost analysis of implementing high penetration of solar PV to a microgrid. However, a more thorough investigation is required to assess the distributed energy storage requirements for integrating high penetrations of solar PV onto a microgrid.

5.2 ANALYSIS METHODOLOGY

The two primary metrics used throughout this analysis are the islanding time a microgrid can support and the net present value (NPV) of the microgrid. There are other important energy security metrics such as reliability and resiliency, and there are other cost metrics such as the leveled cost of energy, but in this study all of the results are presented as a function of NPV and islanding time.

5.2.1 Energy Security

The main metric used to assess microgrid performance in this study is the duration in which it can provide the necessary power to the installation, or **island time**. It is the minimum islanding time over the course of the year that is used. For a microgrid with only generators, the energy is stored in the fuel, and the minimum islanding time is simply the time period with the greatest total demand. The addition of solar PV makes the determination of minimum islanding time a little less clear, because it is both the installation's demand and the solar PV system's generating capacity that determine minimum island time.

To further illustrate the minimum island time metric, Figure 20 shows the profile of island time for each hour of the year for Naval Base San Diego (NBSD), MIT Lincoln Laboratory (MIT LL) and Naval Support Facility Dahlgren (Dahlgren) for a microgrid with diesel generators. The values on the x-axis indicate the time of year when an outage occurs, and the values on the y-axis correspond to the length of time the system can provide power to the installation. In this case, the fuel capacity is set to be sufficient to allow a minimum island time of seven days, no matter when the islanding event must occur. For MIT LL, this worst-case islanding time occurs in the middle of July, the hottest and most energy-intensive time of the year, and for NSF Dahlgren it is late June. The worst-case island time for NBSD occurs a few weeks later, in early August. By scaling energy storage capacity based on these worst-case time periods, it means that the base will be able to support longer islanding periods during the rest of the year.

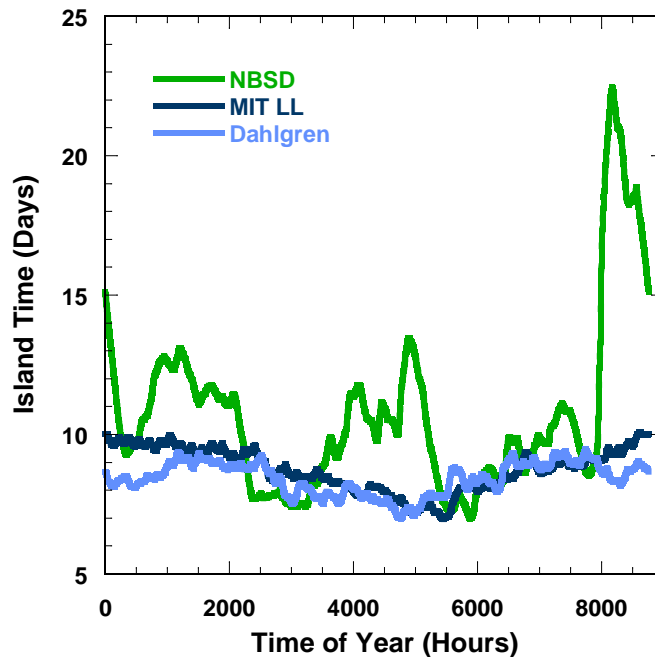

Figure 20. Island time profile with seven-day minimum.

As another way to interpret the curves shown in Figure 20, Figure 21 shows the cumulative distribution function (CDF) of the island time for a minimum island time of seven days. A CDF describes the probability that the variable on the x-axis will occur at or below the value x. For instance, in Figure 21, the line drawn at 0.5 in the y-axis indicates that for 50% of the time Dahlgren and MIT LL will have at least 8.5 days and NBSD will have 10 days of islanding capability for a system designed for a minimum of seven days of islanding. This shows that NBSD has a much higher variability in its demand

profile for the year shown. One caveat to this analysis is that the fluctuation in power use at NBSD is due to when ships are in port and using shore power (as shown in further detail in Section 5.3.2). It seems unlikely that these loads would be serviced by an energy security microgrid; however it provides a useful example of an installation with an atypical load time history.

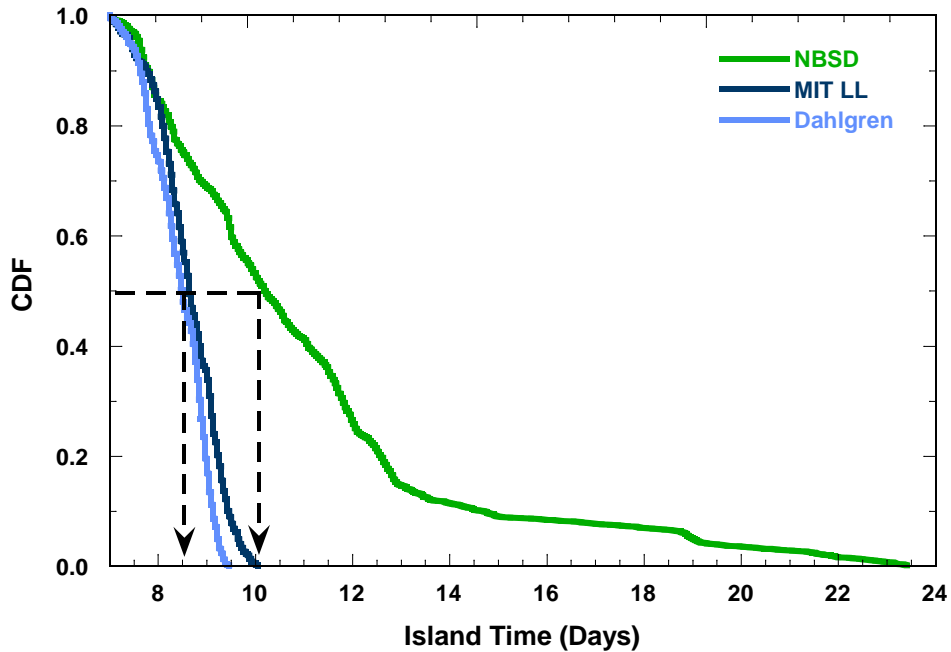

Figure 21. CDF of island time for seven-day minimum.

Results provided in this report assume that the system must have enough capacity to provide power to the installation for 100% of the time for a range of island time between 1 and 30 days. By designing for this worst-case scenario, it ensures that the system is over-designed for an outage occurring at any other day and time. In practice, only a portion of the installation’s loads would be placed on the microgrid system. The analyses in this study assume that 100% of the installation is being incorporated into the microgrid. As discussed in Section 4.3.1, it can be difficult to determine exactly which loads should be considered critical, as it likely depends on the event and duration. As long as the shape of the demand curve does not appreciably change, then the results presented should scale linearly.

5.2.2 Cost Analysis

To determine the total cost of a project over its lifetime, the net present value (NPV) is calculated for each microgrid architecture. NPV is calculated as shown in the following equation:

$$NPV = \sum_{i=1}^{30} (\text{Annual Income}(i) - \text{Annual Expense}(i)) - \text{Initial Cost} . \quad (1)$$

In Equation 1, i represents the year of the project counting from the present year. The annual income or expense of the project for a given year i is calculated in today's dollars using

$$X(i) = X(1) \left(\frac{1}{1 + DR} \right)^i , \quad (2)$$

where X represents the annual income or expense and DR is the real discount rate. An assumption is made that the raw annual income and expense do not change over time. What does change is the time value of money. Equation 2 accounts for the future value of income or expense due to discount rate and in this analysis, i varies from 1 to 30 years. Therefore, Equation 1 can be rewritten as

$$NPV = (\text{Annual Income}(1) - \text{Annual Expense}(1))(\text{PVF}) - \text{Initial Cost} , \quad (3)$$

where PVF is the present value factor and is dependent on the real discount rate and the lifetime of the project, and is expressed as

$$PVF = \sum_{i=1}^{30} \left(\frac{1}{1 + DR} \right)^i . \quad (4)$$

5.3 ANALYSIS INPUTS

The costs of various generation and storage resources, the load profile for an installation, the solar insolation, and the cost of electricity all figure prominently in the cost-benefit trades. This section summarizes the information used in the analysis.

5.3.1 Costs and Financial Inputs

Table 1 summarizes the inputs used in this analysis. The real discount rate of 2.0% is obtained from the White House Office of Management and Budget for 2012 [20]. In the past 10 years, the real discount rates have been fluctuating between 2.0 and 3.2%.

Table 1
Analysis Inputs

Finance	
Real Discount Rate	2%
Generators	
Cost of Assets and Installation	\$350/kW
Additional Cost for Tier 4	40%
Fuel Cost	\$4.00/gallon
Annual OM Cost	4% of fuel cost
DR Payback Rate	\$3000/MW/month
Solar	
Cost of Installation	\$3.50/W
Annual OM Cost	1% of installation cost
Batteries	
Installation Cost	\$650/kWh

Generators

Figure 22 shows the total cost for Tier 2 generators up to 1000 kW in size, including material and installation as published in RS Mean Electrical Cost Data [21], and an estimated additional 25% for overhead cost. For generators with a capacity greater than 400 kW, the total cost asymptotes to a range between \$300 and \$350/kW. In order to convert a generator from Tier 2 emission level to Tier 4 emission level, a price increase of 40% is expected [22]. To date, only Caterpillar markets Tier 4 generators. As more companies include Tier 4 generators in their product line, the cost is anticipated to decrease as a result of market competition.

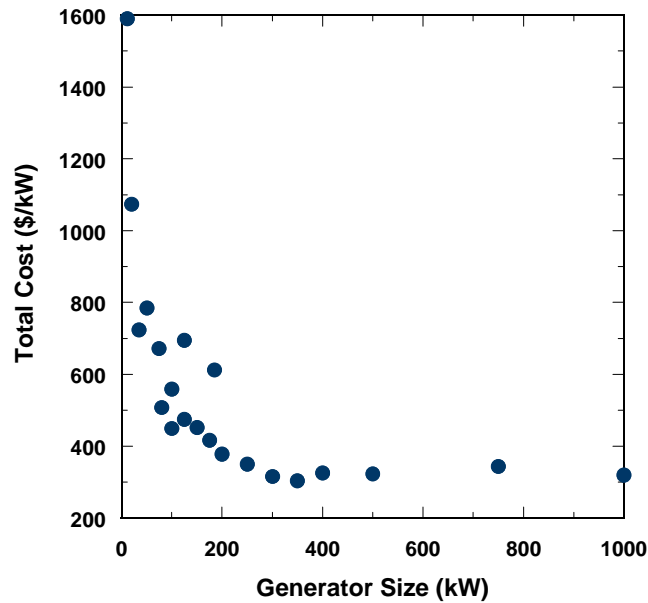

Figure 22. Estimated total installation cost of generators.

For the demand-response program payback rate, \$3000/MW/month is used in this analysis unless otherwise stated [23]. As an example, at MIT LL two generators with a total capacity of 1 MW are enrolled in a demand-response program, and the payback rate is \$3125/MW/month [24].

Solar PV

In recent years, the cost of solar PV has decreased significantly to the point that grid parity is attainable in some locations. Within the last year, the price for PV modules decreased by \$0.85 per watt, which results in a system price decrease of 23–27% [25]. The total system cost for 2011 was modeled to be \$3.43/W for commercial rooftop, which matches both NREL estimates (Figure 23 [25, p.33]), and a price quote received for a 1 MW install of rooftop PV [26]. Therefore, \$3.43/W is the cost of solar PV selected in this study.

Modeled and Fair Market Value Installed Solar PV System Prices

2H 2011 standard c-Si (14.9%) residential and commercial rooftop, utility ground mount systems (fixed, single axis tracking), three standard deviation confidence intervals based on Monte Carlo

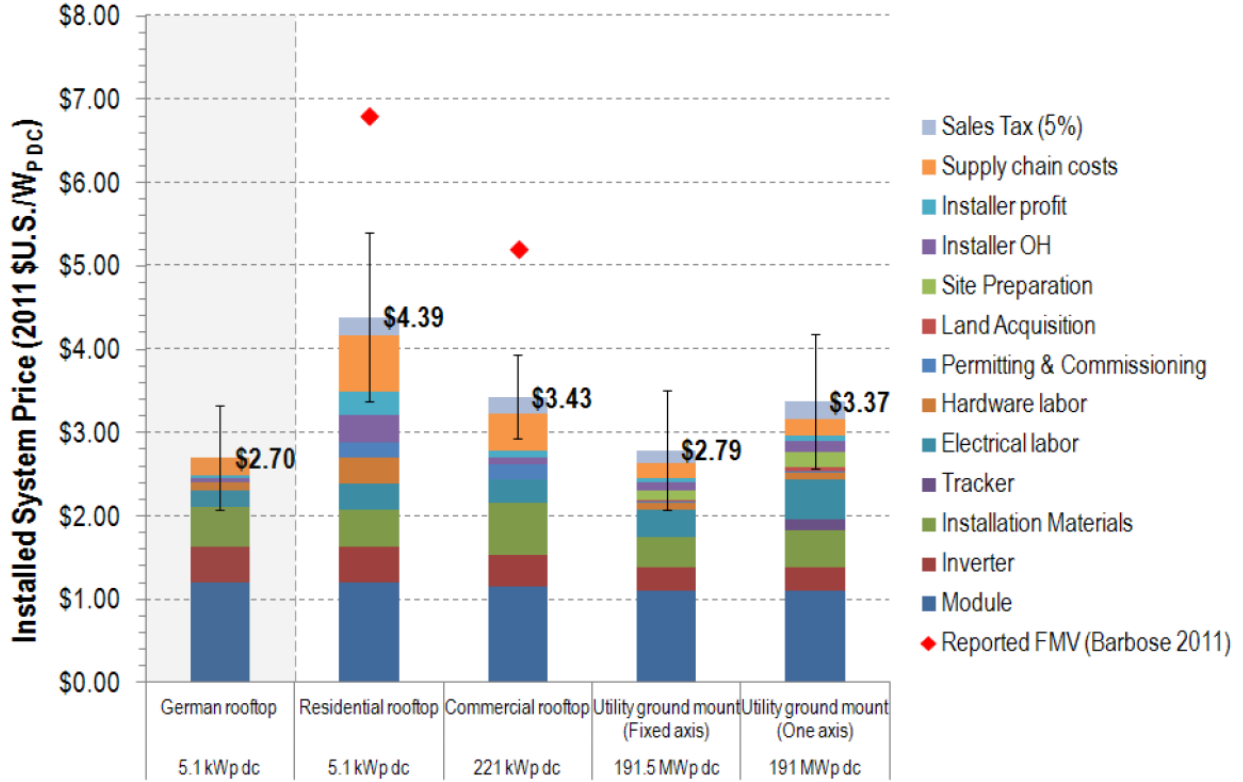

Figure 23. NREL modeled 2011 installed system price for solar PV.

In practice, the most likely method for the widespread deployment of solar PV systems on DoD fixed installations is through a Power Purchase Agreement. In a PPA the installer, or a third party, retains ownership of the PV system after installation and sells the power produced to the base at an agreed upon rate. The owner of the PV system can then benefit from the federal tax credits and can sell the Renewable Energy Certificates (RECs) in the commercial markets. In markets with high quality solar resources and good REC markets, it is possible for an installation to install a PV system with no upfront cost and then purchase electricity at below market rates through a PPA. For example, Nellis AFB saves over \$1M/yr in electricity costs with its 14.2 MW PV array [27].

Battery

Figure 24 shows the expected and target cost of lithium ion battery from A123 [28]. As noted, the current cost is \$500–\$700/kWh, and it is expected to reduce to \$400–\$500/kWh within the next few years – as the automotive industry increasingly purchases more batteries for plug-in electric and hybrid electric vehicles, the price is expected to fall due to economies of scale. In this analysis, the battery cost is assumed to be \$650/kWh.

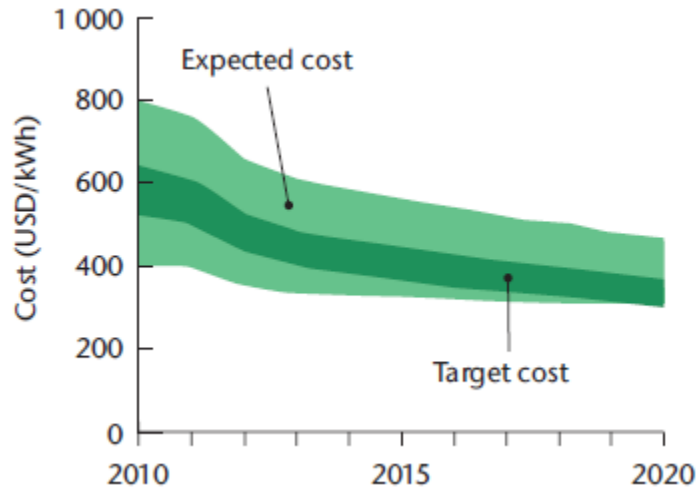

Figure 24. Estimated cost projection of lithium ion batteries.

5.3.2 Installation Load Profiles

Figure 25 shows the hourly power demand for NBSD, Dahlgren, and MIT LL, respectively, for one year of data. Figures 26–28 present the hourly power demand for the three locations in a format to show the demand by time of day (0–24 hours) and day of year (0–365 days). As shown, MIT LL and Dahlgren have a similar profile, which has peaks during the middle of the weekdays and valleys during the nights and weekends. In addition, power demand increases during the summer and decreases during the winter. In contrast, NBSD has a highly variable demand profile that depends on when ships are docked at the base and provided with shore power.

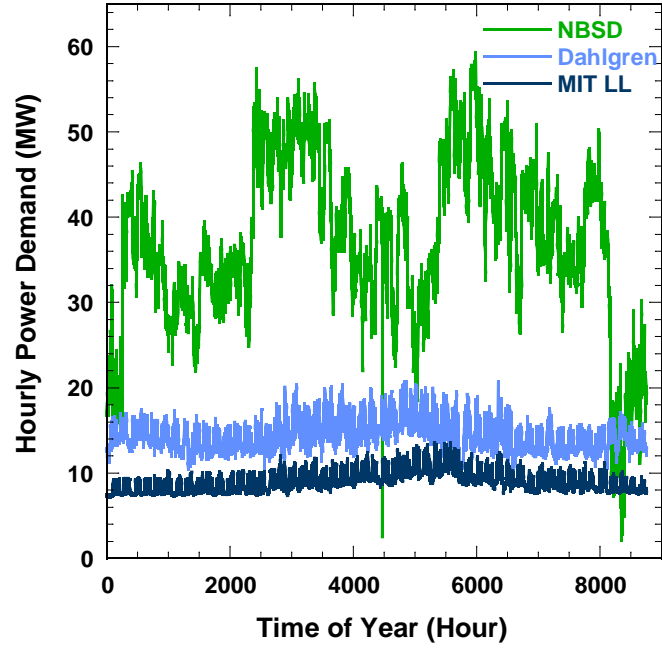

Figure 25. Hourly power demand profiles.

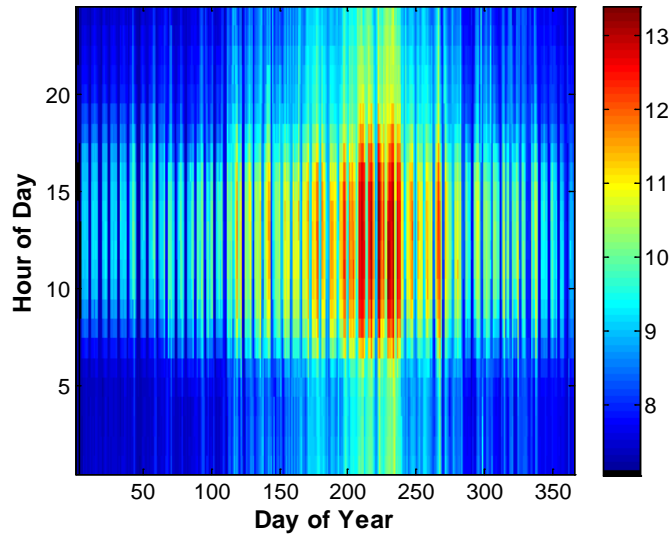

Figure 26. Hourly power demand for MIT LL in MW.

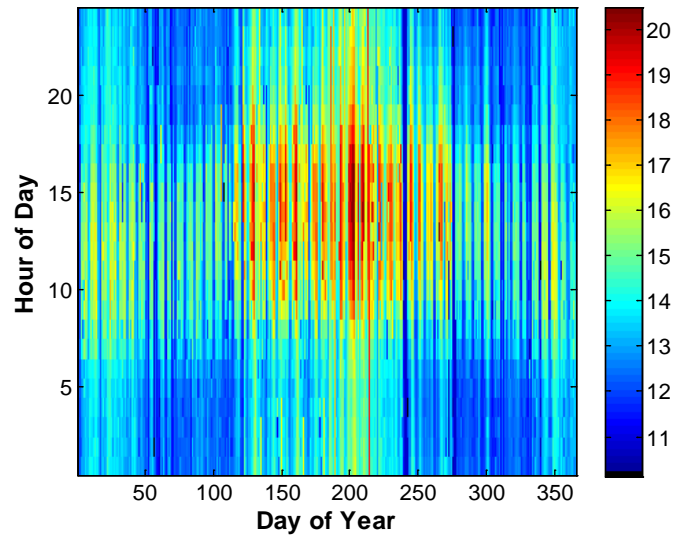

Figure 27. Hourly demand profile for NSF Dahlgren in MW.

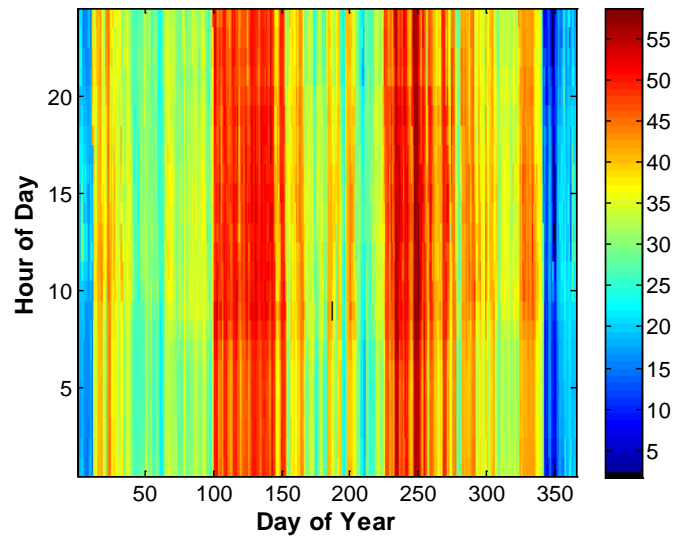

Figure 28. Hourly power demand for NBSD in MW.

The power demand profile is relevant when sizing the microgrid for determining the required minimum number of generators. To size the energy storage capacity, the figure of interest is the total energy demand to island an installation for a desired time. As the islanding time's duration increases, the variability in the total energy demand reduces because short-term fluctuations are smoothed out. Figure 29 shows the energy demand profile for the three locations with a seven day minimum island time.

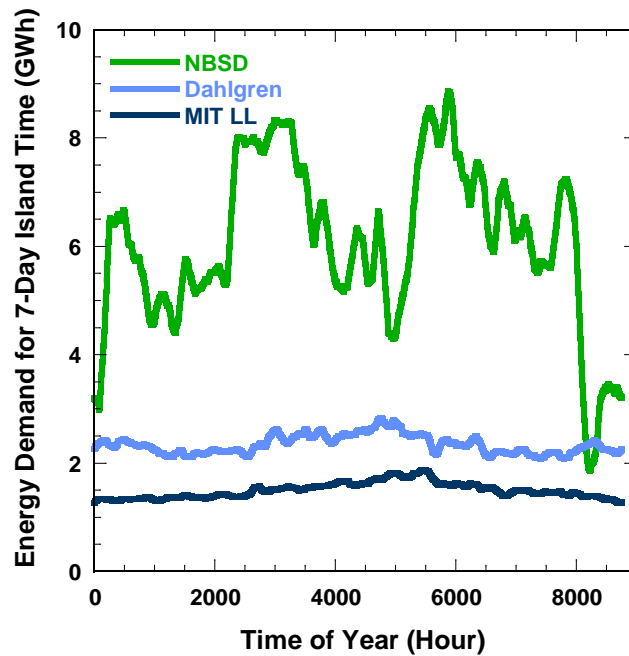

Figure 29. Energy demand profile for seven-day island time.

Figure 30 shows the CDF of energy demand for MIT LL, Dahlgren, and NBSD with seven days of minimum island time. There is a calculated difference of 4% for MIT LL and 6% for Dahlgren and NBSD in the total energy required from the 95th to 100th percentile case. This implies that there are not any severe outliers and that assuming a worst-case scenario does not necessarily indicate a severely oversized system.

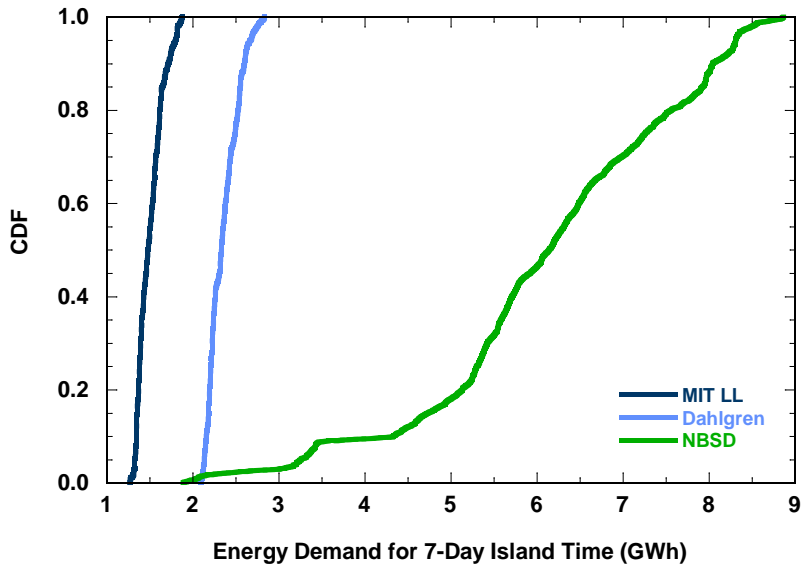

Figure 30. CDF for energy demand for seven-day island time minimum.

5.3.3 Cost of Electricity

This initial analysis assumes the base is using the real-time price of electricity from the local ISO, as shown in Figure 31. This cost includes the real-time pricing of the California ISO, ISO New England, and the PJM interconnection (PJM) for NBSD, MIT LL, and Dahlgren, respectively, and an average energy transmission cost of \$0.0735/kWh. As discussed in Section 4.2, electricity cost structures can vary drastically from one location to another, and therefore using an average transmission cost does not necessarily reflect the true cost, but this should serve as a reasonable first order assumption. Not all of these installations are currently enrolled in real-time pricing (RTP) programs, but RTP offers more flexibility than a flat rate structure and is used in this report to be illustrative.

Figure 31 shows that the cost of electricity at NBSD fluctuates much more than the other two locations, ranging from a negative value to as much as \$1.40/kWh. Despite these fluctuations, the CDF curves in Figure 32 indicate that the price spikes occur fairly rarely, less than 2% of the time. The CDF curve for NSF Dahlgren is similar to that of MIT LL. It should be noted that this only represents one cost structure. In many locations, a consumer's electricity consumption during high demand periods is also factored into the total energy cost.

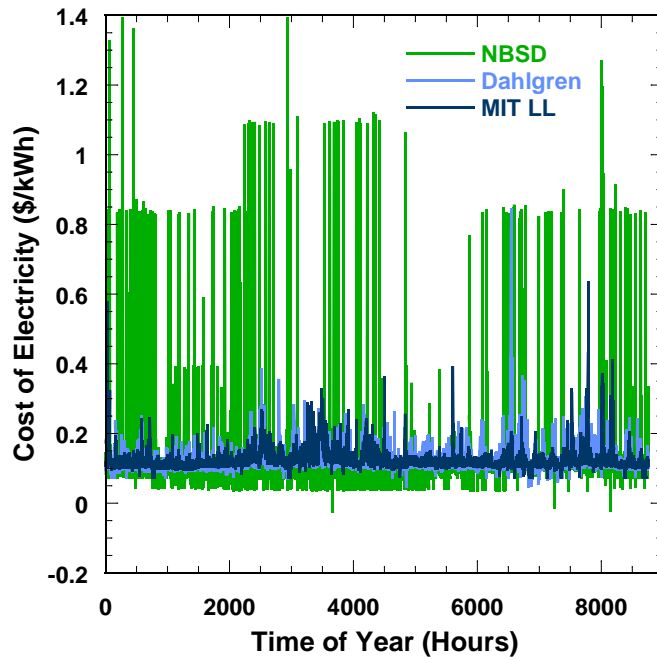

Figure 31. Cost of electricity for NBSD, MIT LL, and NSF Dahlgren.

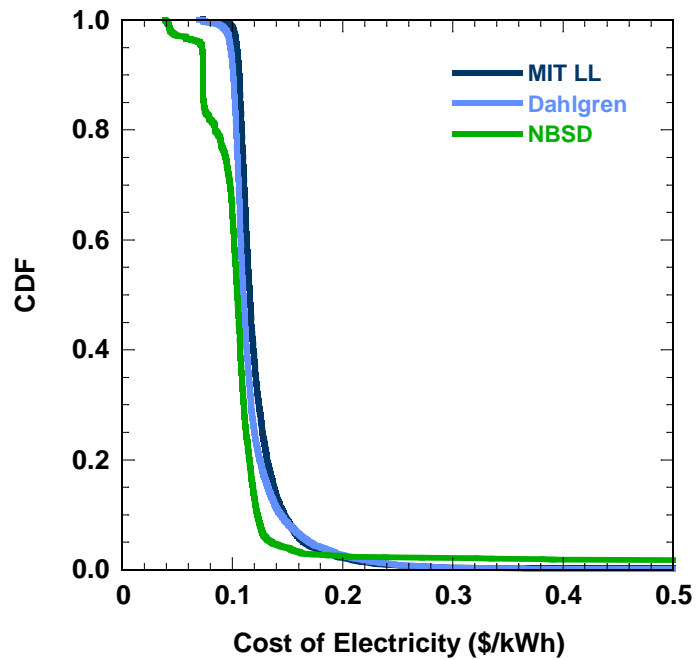

Figure 32. CDF of electricity cost for NBSD, MIT LL, and NSF Dahlgren.

5.3.4 Solar Resource

Figure 33 show the hourly average solar insolation in kWh/m² for NBSD, NSF Dahlgren, and MIT LL, respectively [29]. For all locations, the maximum solar insolation is during the summer months and during the middle of the day, as expected.

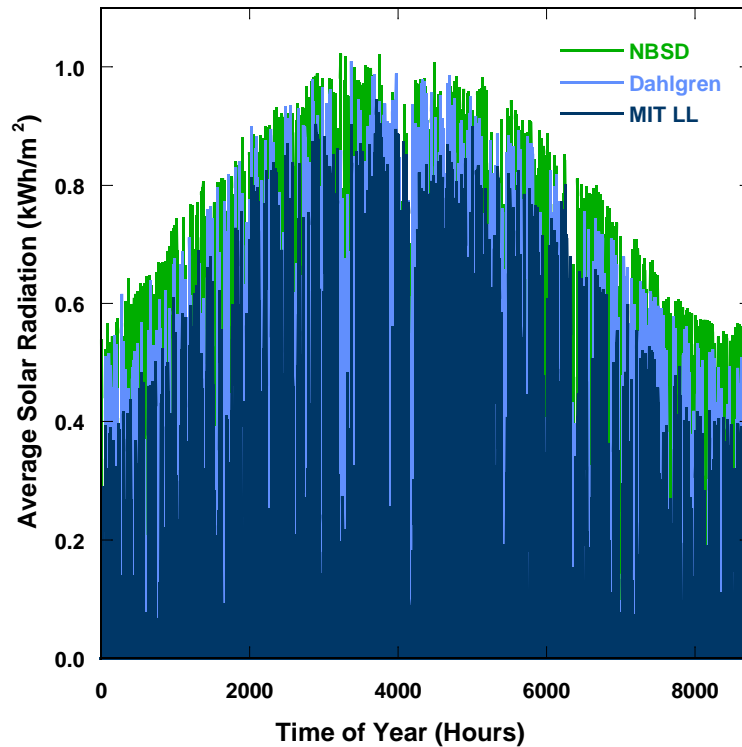

Figure 33. Average solar radiation for NBSD, NSF Dahlgren, and MIT LL.

Figure 34 plots the CDF curves for the total solar energy received for seven-day periods starting at the beginning of each hour in one year for all three locations. The results presented in Figure 34 highlight how the use of minimum island time will discount the benefit of renewable resources to supply increased energy security. The accumulated solar radiation over a one-week time period varies by a factor of 4–5× at each of the three locations. Designing a microgrid that can island during the dead of winter in Boston, or during the rainiest week of the year in San Diego, will naturally lessen the energy security benefit provided by solar PV. However, as described in the following section, it is also the correlation of solar output with peak demand that is critical. During certain times of the year, a PV array may not produce much energy. But if an installation’s loads are small, it may not matter in the design of the microgrid, which will be designed based on worst-case conditions.

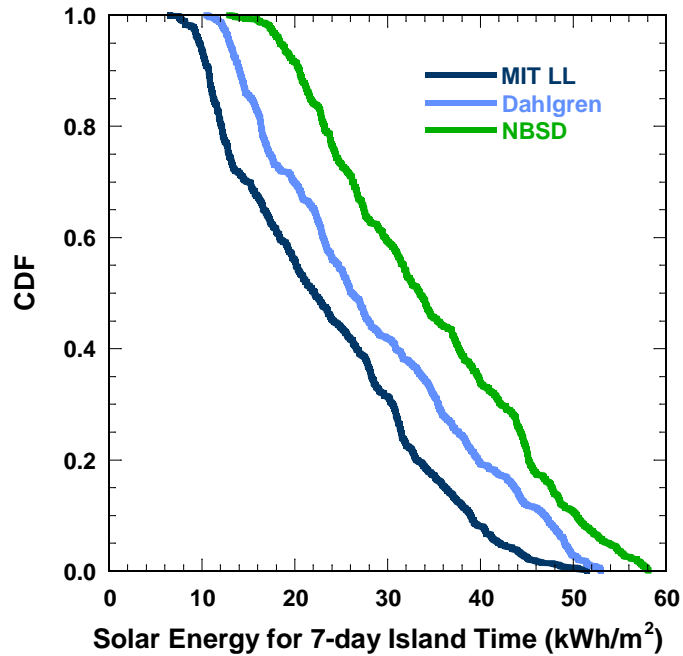

Figure 34. CDF of total solar energy for seven-day islanding time.

5.4 ANALYSIS RESULTS

This section summarizes the main analysis results. The cost tradeoffs between stand-alone and grid-tied generation are presented. A relationship is derived to describe the allowed initial generator installation cost increase as a function of payback rate. The analysis of more advanced microgrids, which include PV and battery storage, is then discussed. Finally, the NPV results for the four microgrid architectures described in Section 5.1 are presented.

5.4.1 Generators (Type 1a and Type 1b)

Installations typically have emergency backup generators to supply critical loads. These systems can be stand-alone systems that cannot parallel with utility grid or they can operate grid-tied. If the generators can operate grid-tied, it is easier to enlist the generation assets in a demand-response program. Recent EPA regulations will require generators that participate in demand-response programs to have Tier 4 emissions certification. This analysis examines the allotted price increase from Tier 2 to Tier 4 generators for a range of financial payback from demand-response programs.

Recall that different tier classifications for generators correspond to emission levels. Assuming that the engine efficiency for Tier 4 is the same as that of Tier 2 generators, the relationship for the Tier 4

generator's allowed initial installation price increase (x) and payback rate (PR) from participating in demand-response program is

$$x = \frac{PR * PVF}{IC},$$

where IC is the initial cost of Tier 2 generators and PVF is 22.4 for a discount rate of 2%. If Tier 2 generators in Type 1a microgrid architecture have an initial cost of IC and the annual payback rate is PR for Tier 4 generators in Type 2a microgrid architecture, then the maximum initial installation cost for Tier 4 generators must be $(1+x)IC$ in order for the NPV of the two architectures to be equivalent.

Figure 35 illustrates this relationship by plotting the allowed increase in cost of Tier 4 generators compared to Tier 2 as a function of demand-response payback rate (PR) for Tier 2's initial cost (IC) of \$200, \$300, and \$400/kW. If there is no payback from the demand-response program, then the allowed increase is 100%, meaning that a Tier 4 generator must cost the same as Tier 2. The typical upfront cost for a Tier 2 generator is \$350/kW. Assuming a reasonable demand-response payback rate of \$3000/MW/month, the Tier 4 generator's initial cost can be up to 330% the cost of the Tier 2 generator, over \$1000/kW, and still pay for the difference over the lifetime of the generator. Based on data from the generator manufacturers, it appears as though the delta in cost between a Tier 2 and Tier 4 unit is approximately 140%.

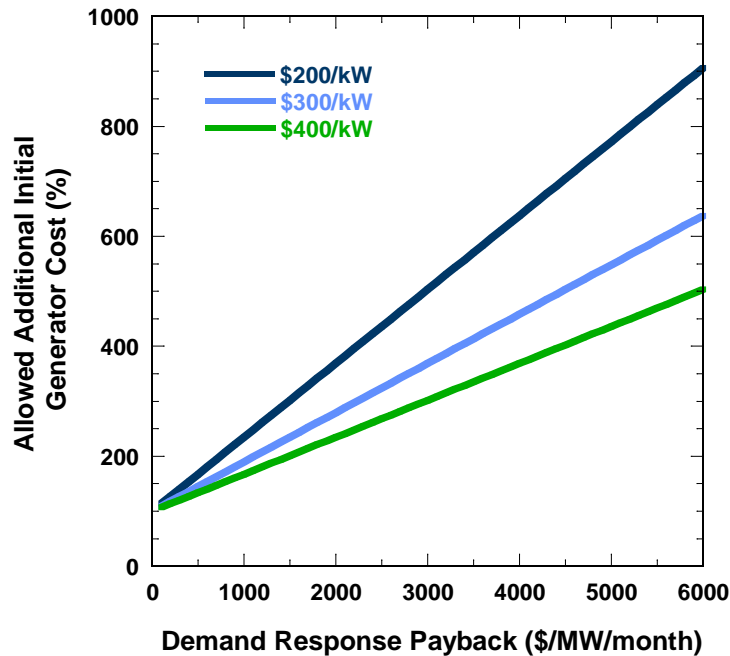

Figure 35. Allowed initial generator cost increase for a range of demand-response payback rates.

5.4.2 Solar PV (Type 2b)

The costs of solar PV are beginning to approach grid parity prices over much of the country. Figure 36 shows the required average electricity cost in three locations in order for solar PV to reach grid-parity. The required average electricity cost is highest for MIT LL and lowest for NBSD. This is due to both the greater resource availability in San Diego and the higher electricity prices. For a solar PV cost of \$3.43/W, the required average electricity cost is \$0.14/kWh, \$0.10/kWh, and \$0.12/kWh for MIT LL, NBSD, and NSF Dahlgren, respectively. The current calculated average electricity cost from the data presented in Section 5.3.3 is \$0.11/kWh, \$0.12/kWh, and \$0.12/kWh for MIT LL, NBSD, and NSF Dahlgren. From these results, solar PV has reached grid parity for NBSD and NSF Dahlgren, but not for MIT LL. This assumes a 30 year project lifetime, a government discount rate of 2%, and no tax incentives.

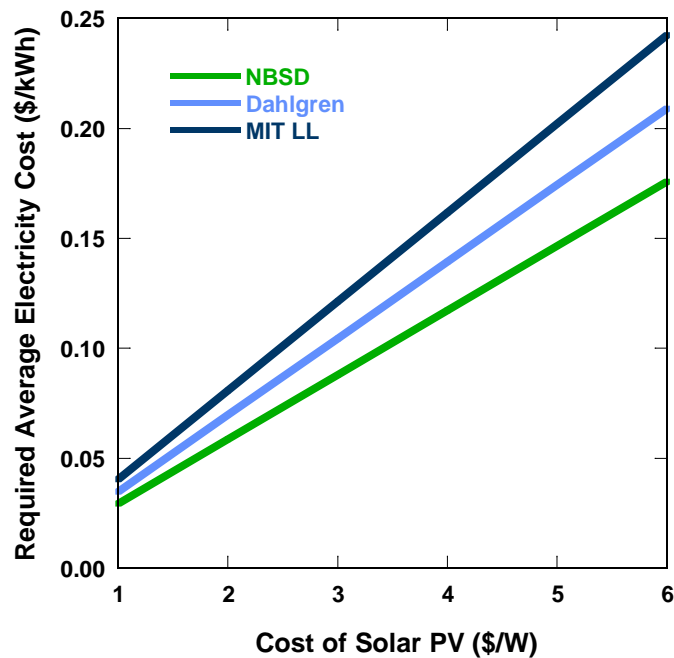

Figure 36. Required average cost of electricity for solar PV to reach grid parity.

A second method to view the cost competitiveness of solar PV is to determine what price a PV panel needs to be to match the cost of electricity in the local market. Table 2 shows the cost competitiveness of solar PV at the different installations and the effect of the real discount rate on the competitiveness of PV.

Table 2
Cost Competitiveness of Solar PV

Location	Electricity cost to reach grid parity, PV=\$3.43/W		Cost of PV to reach parity given today electricity prices	
	2% Discount Rate	5% Discount Rate	2% Discount Rate	5% Discount Rate
MIT LL	\$0.14/kWh	\$0.19/kWh	\$3.18/W	\$2.33/W
NBSD	\$0.10/kWh	\$0.14/kWh	\$3.89/W	\$2.85/W
NSF Dahlgren	\$0.12/kWh	\$0.16/kWh	\$3.53/W	\$2.59/W

At higher real discount rates, PV is not yet at grid parity without tax incentives or renewable energy certificates. As such, the most likely method for installing large-scale PV on DoD installations would be to involve a third-party installer who can benefit from tax incentives and the selling of RECs. Electricity would then be sold back to the base through a PPA at below market prices.

For a microgrid with solar PV, the requirements for conventional generation assets and energy storage will be derived based upon the most difficult islanding conditions. Because solar insolation values fluctuate considerably, it is possible to find periods during the year when very little energy is available. Figure 37 shows the worst case solar insolation that can be expected for all three locations for an islanding time between 1 and 30 days. The results show a similar trend for each location. It indicates that as island time increases, the worst case solar energy produced reaches an asymptotic value, which approaches the average winter-time solar insolation at a given location. These results emphasize the benefit of extending island time to remove short-term fluctuations in solar production.

In sizing a microgrid with solar PV, it is not just the amount of energy that the system supplies that is important, but how that generation capability is correlated to the demand profile on base. Figure 38 shows the potential fuel saved per MW of solar PV as a function of island time.

Notice that the lines are nearly constant slope, indicating that the amount of solar energy used by the microgrid increases linearly with island time. This would appear to contradict the results shown in Figure 37. However, because in these examples the solar insolation is very closely correlated with the load profile on the installation, the worst time period for solar PV is never factored into the minimum islanding time calculation. The microgrid is always sized to meet worst case conditions, which is almost always during the hot summer months when both demand and solar insolation is highest.

There is, however, no guarantee that this will always be true. Certain critical loads may have a much more consistent load profile and be less well correlated with intermittent renewable generation. In those situations, the real benefit of the renewable generation will only be found in extended duration islanding events.

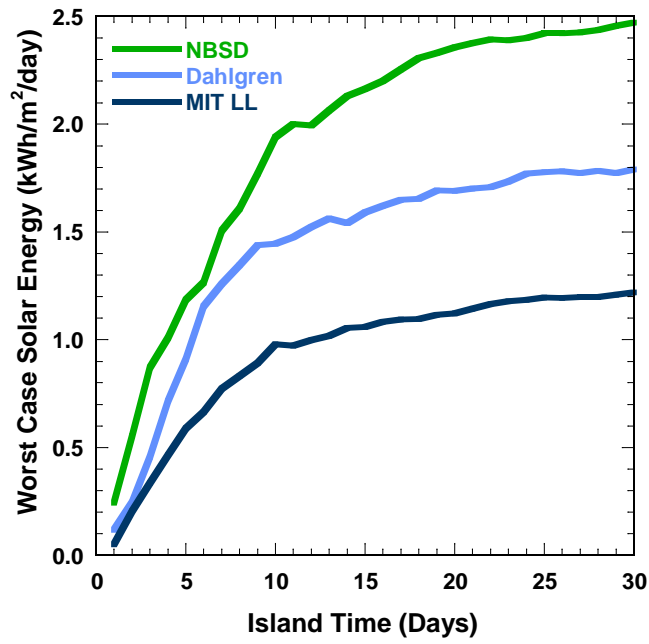

Figure 37. Worst case total daily solar energy per m^2 .

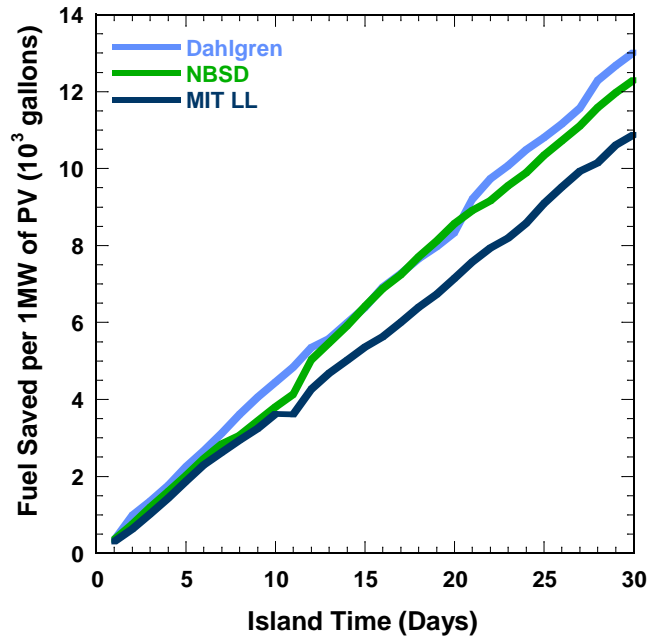

Figure 38. Potential fuel saved per 1MW of solar PV.

5.4.3 Battery and High Penetration PV (Type 2b)

At the current cost of batteries, \$500–\$700/kWh [30], it is not economically viable to use batteries as the main energy storage to provide power during an islanding event. As an example, for a minimum of seven-day island time, the total energy storage required, assuming 100% PV penetration, would be close to 1 GWh for MIT LL and much higher for NSF Dahlgren and NBSD. Even at \$500/kWh, the initial battery cost would be several hundred million dollars. A system with solar and batteries will have to be supplemented with fuel storage and conventional generation to be cost effective.

Even though it is not viable to island an entire microgrid system on batteries and intermittent renewable generation alone for extended periods of time, in modest quantities there are a number of potentially cost effective applications for batteries on a microgrid. These include smoothing short-term transients from either generation or demand, supporting a smooth transition from grid-tied operation to islanded operation, or allowing generation equipment to run closer to peak power output and thus more efficiently. In addition, there are a number of mechanisms that the energy storage device can pay for itself during non-islanded operation, particularly through participation in the ancillary services market.

For the summary analysis presented in Section 5.4.4, batteries are only used as an enabler to incorporate higher PV penetrations on a microgrid. The potential cost savings of enlisting batteries in ancillary services or using them for peak shaving, as the Ft. Bliss microgrid will demonstrate, were not explored during this analysis.

5.4.4 Results Summary

NPVs are calculated for the four microgrid architectures described in Section 5.1. The methods outlined in Section 5.2, along with the analysis inputs presented in Section 5.3, are employed in this analysis.

Figures 39–41 present the NPV results of the four microgrid architectures for MIT LL, NBSD, and NSF Dahlgren, respectively. In all three locations, the NPV values for grid-tied Tier 4 generators architecture (Type 2a) are higher than those of non-grid-tied Tier 2 generators architecture (Type 1a). This is consistent with the calculation shown in Section 5.4.1. In all three locations, the NPV is positive for the more promising architectures with islanding times of fewer than five days.

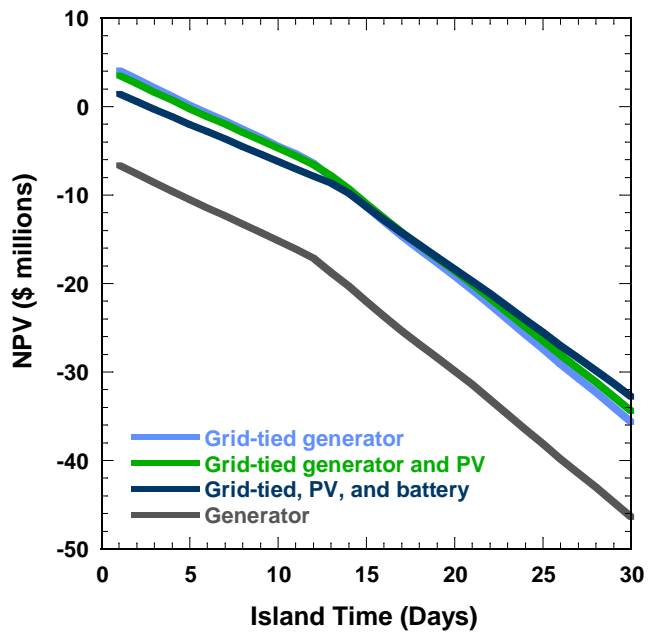

Figure 39. NPV for MIT LL.

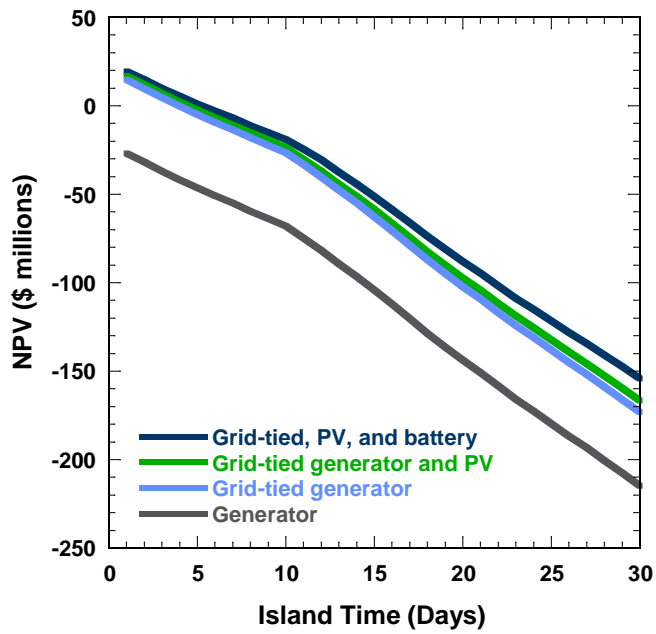

Figure 40. NPV for NBSD.

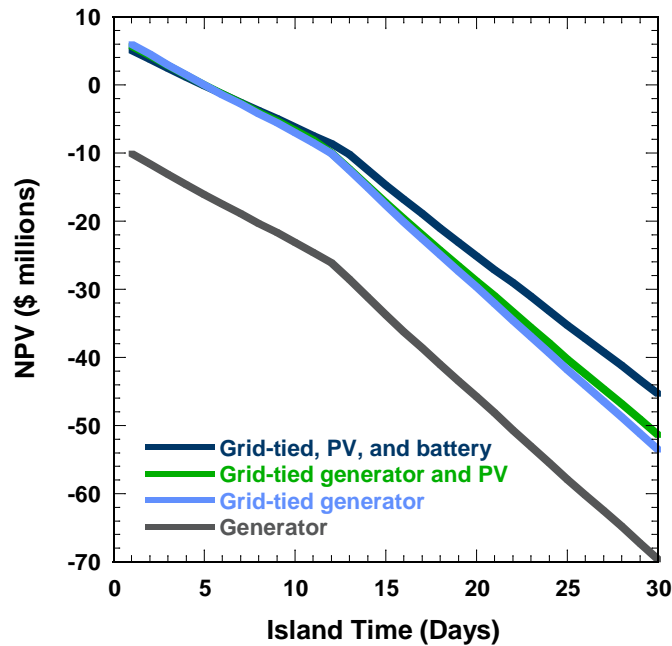

Figure 41. NPV for NSF Dahlgren.

The Type 2a and the two Type 2b architectures had fairly comparable results for short duration islanding. For MIT LL, where PV is not yet grid competitive, the generators and demand-response solution was preferred for shorter islanding times. At Dahlgren and NBSD, where PV is at or approaching grid parity (given the OMB discount rate), the architecture that included the higher PV penetration was most cost effective. For longer islanding times, the Type 2b case with high penetrations of PV was most cost effective in all three cases. At MIT LL, the crossover point at which the architecture including PV is preferred occurred at 15 days of islanding. This crossover point will depend heavily on the cost assumptions that were made.

In all cases, the NPV is a large negative value for longer islanding. This is mainly due to the assumption that fuel stored is sized to match the required energy demand during island time. Therefore, for a longer island time, the required fuel storage is larger. In this analysis, it is assumed that fuel lasts approximately one year without degradation and that, at the end of the year, the generators will run for 200 hours to recover some savings through electricity generation. Beyond the 200 hours, it is assumed the fuel was not used. This approach is conservative as there are fuel reconditioning programs that can help alleviate some of this cost. Also, installations with airfields might have significant fuel reserves already on hand that could be used for electricity generation in a situation that requires extensive off-grid operation.

There are several potentially cost-effective options for extended duration islanding that were not explored here. These include nonintermittent renewable generation on base, such as geothermal or land fill gas systems; natural gas-fired generators and turbines that do not require local fuel storage, although the resiliency of the natural gas delivery system would need to be examined; and potentially higher intermittent renewable penetration then modeled, combined with large energy storage systems funded through ancillary services, with intelligent load shedding to better match demand and supply.

For a requirement of short-term islanding (on the order of less than a week), conventional assets that leverage programs like demand response could be cost effective. For longer duration islanding, a more sophisticated system will be required. Through tighter integration with the larger macrogrid, it is likely that a substantial amount of the cost of these advanced microgrids could be offset by participation in the different ancillary services markets, particularly for those installations that are located in wholesale energy markets. In addition, more advanced microgrids will ease the integration of intermittent renewable generation, optimize building loads and improve efficiency, and provide a more resilient, flexible, and extensible energy system for DoD installations.

6. RECOMMENDATIONS

- The most cost-effective microgrid solutions will likely be those that take into account the needs of the local commercial electric grid. In areas where commercial generation resources are stretched thin, or with significant congestion on the electric grid, local generation can play an important role. The generation resources on an installation would then be at least partially funded by the local utility either directly or through demand-response programs or the ancillary services market. These approaches should be thoroughly explored.
- The biggest value in the ancillary services markets are those services that require very fast response times and thus tight integration with the larger macrogrid. Technologies that could have significant benefit for off-grid operation are the same technologies best suited for these faster responding services, including energy storage and automated load management. Additional research will be required to better define the microgrid/macrogrid interface including security provisions and control mechanisms.
- Solar PV is approaching grid parity in certain parts of the country. This is particularly true when the PV system is not purchased directly by the DoD but is financed through a power purchase agreement that allows a third party to retain ownership of the PV system and benefit from various tax incentives. DoD fixed installations are particularly promising locations for renewable generation due to the availability of high quality land and the location next to a large load center. As such, the DoD has begun installing PV systems on a number of bases. The PV should be able to provide added energy security benefits assuming the system is designed, and the contractual language is in place, that will allow the base to utilize the PV system during a grid outage.
- For prime PV locations, it is possible that microgrids with very high percentages of PV penetration may be a cost-effective solution. These microgrids carry a number of risks. In particular, the low inertia on a PV-based power grid means that power quality issues could arise with fast load transients. Various technologies, including batteries and flywheels, could help ameliorate this problem, but further research will be required.
- In order to encourage the development of microgrids on DoD installations, it would be useful to place a value on energy security. This value would be a cents/kWh premium that the military would pay for reliable power. This value would presumably be dependent on the function the installation (or the portion of the installation) performs. This model is already in use at Fort Detrick for the microgrid that supplies the National Interagency Biodefense Campus.
- Cyber security concerns are a significant detriment to microgrid development. The DoD should develop/certify a set of DIACAP-approved devices that can be used across the services for energy management systems.

- The requirements for DoD installation microgrids need to be better defined, including requirements for islanding time and grid reliability.
- In developing microgrid architectures, the DoD needs to be cognizant of the legacy infrastructure on each installation. This will likely be one of the primary cost determinants for the development of energy security microgrids and needs to be considered on an installation-by-installation basis.

APPENDIX A

BRIEF DESCRIPTIONS OF MICROGRID EFFORTS

Brief descriptions of all microgrid efforts are divided by service and are divided into those under the Air Force, Army, Navy, Marines, and those efforts at joint bases. Efforts are listed alphabetically.

AIR FORCE

ANG Fargo: Existing 1.825 MW Type 2a microgrid

ANG Fargo has a whole base generator that was bought because of feasibility studies that were done that showed that the positive economics of existing demand-response programs made it cost effective to install the generators. If the local utility is at peak, they start their own generator and then they are on their own generation. It was unclear as to whether the unit at Fargo can push back into the grid. Some have said it can, some not. It was speculated that as the meter does not go backwards, that may be the reason people say it cannot operate in parallel with the utility.

ANG ST. Paul: Existing 2 MW Type 2a microgrid

ANG St. Paul has a whole base generator that was bought because of feasibility studies that were done that showed that the positive economics of existing demand-response programs made it cost effective to install the generators. If the local utility is at peak, they start their own generator and then they are on their own generation. They operate in a completely isolated, not parallel, mode.

ANG VOLK Field: Existing 2 MW Type 2a microgrid

ANG Volk Field has a whole base generator that was bought because of feasibility studies that were done that showed that the positive economics of existing demand-response programs made it cost effective to install the generators. If the local utility is at peak, they start their own generator and then they are on their own generation. Their 2 MW generator is enrolled in the local utility's demand-response program. The generator has a soft transition with the utility system for seamless transfer of power, but does not typically operate in parallel with the grid.

Buckley AFB: Reported 1 MW diesel generator microgrid

Our contact did not think that the reported generators at Buckley AFB constituted a microgrid.

Cannon AFB

Conceptual design study by Sandia National Laboratories.

Cape Canaveral AFS: Existing 7.5 MW Type 1a microgrid

Cape Canaveral AFS has diesel generators at substations to supply power in event of a grid outage.

Clear AFS: Existing 0.3 MW Type 1a microgrid

Initial study documents described a microgrid at Clear AFS, but we were unable to determine what the configuration is and how it interacts with the coal-powered generation that is there.

Creech AFB: Reported 1.5 MW temporary tie-in

Despite repeated attempts, we were unable to make contact with someone with information for microgrids at Creech and Offutt AFBs.

Dyess AFB: Existing 11 MW Type 2a microgrid

Dyess AFB has five 2.2 MW diesel generators connected at one substation. They operate under a real-time pricing schedule within ERCOT and use the diesel generators and an ice storage system for peak shaving purposes. The diesel generators can operate in parallel with the utility grid and supply all of the base's power depending on the time of the year (13.5 MW summer peak). Dyess AFB is installing advanced controls on their lighting and HVAC systems which will allow them to enlist in the automated demand-response ancillary services market. The base has plans to install a waste-to-energy plant (up to 5 MW in size) via a PPA. A previous plan to install a waste-to-energy plant through an ESPC fell through.

The information received on Dyess AFB was very late in this study and could not adequately be reflected in the main body of this document.

Eielson AFB: Existing 16 MW Type 1a microgrid

Eielson AFB is completely powered by a CHP plant on base, except for in July and August when it is shut down for maintenance for a month. They operate grid connected during that month, but have relatively low demand requirements. The installation maintains a modest contract with the utility in case the CHP plant is lost for a short time; the installation would then depend on the utility power to provide the signal required to resynchronize and reconnect the CHP plant. The plant cannot back-feed the grid. They use coal to run the boiler and a steam turbine for electricity and heat. There is also a 1.5 MW diesel generator to black-start the rest of the plant. [It is unclear why, if they have black-start capability with this 1.5 MW generator, it was mentioned that they needed the grid interconnection to allow the CHP plant to restart.]

Kirtland AFB

Conceptual design study by Sandia National Laboratories submitted to ESTCP.

Kunsan AB, South Korea: Existing 3 MW Type 2a microgrid and 3 MW Type 1a microgrid

Kunsan AB has eight diesel generators (MEP-12s, 750 kW each). Four of the units are at the switching station downstream of the KEPCO (Korean Electric Power Company) substation that serves the base. These four units tie to all the feeders at the main switching station and can be used to power the base in the event of a grid power outage. The other four are located at two different substations and are tied

directly to the feeders as dedicated units; they do not operate in parallel with the utility grid, but are used when the loads served by that feeder are isolated from the rest of the grid. Every year, KEPCO requires 48 hours of downtime for their yearly preventive maintenance at the substation. The generators are only used when the base has lost utility power.

Joint Base San Antonio /Lackland AFB: Study for a 0.5 MW Type 2b microgrid

A study was done for a system with 500 kW of lead-acid batteries and a PV system. Not funded.

Maxwell AFB: Underway 1.2 MW Type 2a microgrid

Maxwell AFB has two existing 600 kW backup generators, a new 100 kW generator, and plans for 500 kW of PV. The microgrid is being developed on the Sandia/CERTS microgrid model with automated transition to islanded mode and distributed controls.

McConnell AFB: Existing 3 MW Type 1a microgrid

McConnell AFB has two 1.5 MW diesel generators. The system is there as a backup system and it was not known to our contact if they can operate in parallel with the utility system.

Joint Base McGuire-Dix-Lakehurst AFB: Demo of a 0.08 MW Type 2b microgrid

An ESTCP building-level demonstration project was done at McGuire AFB to demonstrate peak shaving using solar power and batteries. It consisted of 75 kW solar PV, 25 kWh LiI battery, and an 80 kW power cell. It did not interface with the building loads because of restrictions on network connections and was therefore also unable to communicate with an outside power supplier to get real-time pricing data. The final report was not completed at the time of contact.

Offutt AFB: Reported existing 12 MW microgrid and a planned 25 MW microgrid with diesel generators

Despite repeated attempts, we were unable to make contact with someone with information for microgrids at Creech and Offutt AFBs.

Osan AB, South Korea: Existing 4.5 MW Type 1a microgrid

Osan AB, Korea has six MEP-12s (750 kW) located throughout the base and connected directly to several 13.8 kV overhead feeders. All the MEP-12s are paired with step-up transformers 4.16 kV to 13.8 kV. They are spread onto six different feeders, are localized, and cannot pick up the base load. They can provide backup power to the specific feeder that they are connected to. No switches or ability to synchronize to the grid.

Patrick AFB: Existing 6.6 MW Type 1a microgrid

Patrick AFB has two diesel generators at a substation to supply power in event of a grid outage.

Robins AFB: Existing 160 MW Type 2a microgrid

Tinker AFB and Robins AFB have on-site combustion gas turbines, owned and operated by their respective local utility companies, which provide power to the installations in the event of a power outage. Each base was approached independently by the utility companies when they were looking for a location to site peaking power plants. The generators were installed and paid for by the utility companies, with the base providing the land.

Robins AFB has an on-site combustion gas turbine plant consisting of two 80 MW generators. Operated by Georgia Power, the Robins plant is a peaking power plant during normal operation but, like the Tinker AFB power plant, can be islanded with the loss of grid power (this capability was tested three years ago at Robins). Normally the generators' gas turbines run on natural gas, but there is a 1.3 million gallon diesel tank for backup (corresponding to about 18 days of operational capacity). There is also a 3 MW generator used to black-start the grid if both larger generators go down. In practice, though, the generators would most likely never operate in an islanded mode, as they tie into the Georgia power 115 kV primary line and feed loads off the installation as well. Restarting the grid and service decisions would be made by the utility company, but given the proximity of the base to the generation, Robins AFB is likely the first customer restored to power.

Schriever AFB

Study of local renewable resources by Sandia National Laboratories.

Stewart AGS: Study for a 0.3 MW Type 2b microgrid

The contract has been awarded to do a study to plan how to install and integrate 250–500 kW of PV into a base microgrid. They are currently doing an assessment of the environment and use of power on the base to understand the requirements. The installation needs 24/7 operation, so it will need to island for increased energy security. Stewart is in the New York metropolitan area and does a lot of the supply runs over to the European theater. There will be need to be storage of some type on the microgrid, but details are still to be determined.

Tinker AFB: Existing 80 MW Type 2a microgrid

Tinker AFB and Robins AFB have on-site combustion gas turbines, owned and operated by their respective local utility companies, which provide power to the installations in the event of a power outage. Each base was approached independently by the utility companies when they were looking for a location to site peaking power plants. The generators were installed and paid for by the utility companies, with the base providing the land.

Tinker AFB has two utility owned-and-operated 40 MW generators in one of the substations that operate routinely in the summer, but provide backup, islandable power for the base in the event that the grid goes down. The base has first rights to the power and, in the event of a grid power blackout, the generators can be used to black-start the utility grid. This black-start or islanding operation has yet to be

operationally tested at Tinker. Many facilities on base also have backup generators for systems like exhaust fans in hazardous locations that Air Force Instructions require redundant diesel backup. The 40 MW generators have about three days of backup JP-8 fuel for power generation. They began operating in 1988 and are on a second 15-year contract period. In addition, the utility at Tinker AFB wants to build a 250 kW solar array. The building targeted is on the 15 kV distribution system and would also be islandable, with the rest of the 80 MW backup power.

United States Air Force Academy: Study for a 6 MW Type 2b microgrid

The U.S. Air Force Academy has 6 MW of existing PV that they get power from through a PPA. It is grid-tied and not islandable. They have a study with NREL to look at the feasibility of making a microgrid on site. It is unclear whether the existing PV will be part of it or not, as the location of the PV is not near the planned microgrid site.

Vandenberg AFB: Existing 15 MW Type 2a microgrid. A study has also been performed

Vandenberg AFB has five 3.05 MW generators to provide power to launch operations that need two sources of power for contingency operations. The generators can run in parallel with the utility system and are tied-in to a substation for automatic transfer in the event of loss of utility power. They have run exercises with the utility for peak shaving, and could push power back into the grid, but they don't by policy. A conceptual design study for wind power by Sandia National Laboratories was also performed.

Whiteman AFB: Reported 1 MW generator with step-up transformer to distribution voltage

Despite repeated attempts, we were unable to make contact with someone with information for the reported microgrid at Whiteman AFB.

ARMY

Fort Belvoir: Study for a 1.8 MW Type 2a microgrid

A proposal based on a design by Sandia National Laboratories that will include a CHP component: 1 MW trigeneration with 800 kW backup diesel generators was submitted to ESTCP.

Fort Bliss: Underway 1 MW Type 2b microgrid. A study has also been performed.

The Fort Bliss microgrid development is in process as of March 2012. The project aims to construct a microgrid that will be integrated into the dining facility of the Battalion Combat Team-1 (BCT-1) complex at Ft. Bliss, Texas. The total peak power of the microgrid will be approximately 600 kW, with the expectation that it will be a scalable solution.

The goals of the Ft. Bliss microgrid are to reduce green house gas emissions, lower operating costs, and enhance the energy security of the installation. The microgrid consists of existing diesel backup generators (250 kW), an existing PV array (100 kW), and a new lead-acid battery (300 kW/60 kWh).

Advanced controls will be integrated into both the existing PV inverter and the diesel generator to allow for islanded operation and advanced performance optimization.

The architecture of the Ft. Bliss microgrid is designed to be flexible with distributed control at each distributed energy resource (DER) interfacing onto a common integration bus. The distributed controllers interface with a centralized microgrid controller that optimizes the dispatching of DER resources, aggregates and displays system performance, and could act as a single gateway to the utility EMS.

The utility rate structure at Ft. Bliss includes both a significant demand charge based on the peak demand (kW) during each monthly period and very different on- and off-peak energy charges during the summer months. By shaving peak demand and shifting demand to off-peak time periods, the Ft. Bliss microgrid will aim to reduce overall operational costs of the system. Both the battery and the diesel generator will participate in the peak shaving activity, although the generator will be limited due to emissions requirements.

Peak shaving requires knowledge of the installations energy demand, but does not necessarily require a direct tie to the utility EMS. Still, this is an important initial demonstration of the dual usage of energy storage devices, both to provide additional energy security while off-grid and cost savings during grid-tied operation.

The installation is also looking at an ESPC project (112 kW at a range facility, 112 kW at another range, 1 MW on post).

Fort Bragg: Existing ~5 MW Type 2a microgrid. A study has also been performed.

At Ft. Bragg, there were Encorp virtual power plant systems installed at three locations to do peak shaving. One location paralleled three 850 kW gensets, a second location had a 1.5 MW genset, and the last location had fifteen gensets that ranged from 400 to 800 kW. The system has been abandoned at the first two locations. The last location has eleven generators still being controlled by the Encorp system. Our contact at Ft. Bragg said that they believed the systems were abandoned due to poor support from Encorp.

There was also a microgrid study done at Ft. Bragg where the goal was to come up with a methodology to plan for an island.

Fort Carson: Planned 7 MW Type 2b microgrid

The Smart Power Infrastructure Demonstration for Energy Reliability and Security (SPIDERS) JCTD is a multiphased joint effort to develop microgrids in a cyber-secure manner. SPIDERS is a collaboration between several of the DOE Laboratories with several organizations within the DoD, and is led by the U.S. Army Corps of Engineers. The effort is subdivided into three phases, with build-out efforts at Joint Base Pearl Harbor Hickam (JBPHH) (Phase 1), Fort Carson (Phase 2), and Camp Smith (Phase 3). The goal is to deploy or apply technology over legacy systems, looking at the technical feasibility as well as the business case and value proposition. Phases 2 and 3 are adding element of cyber

security to allow situational awareness and the ability to coordinate power demands with the utility provider.

The Request for Proposals (RFP) for the second phase at Fort Carson was released in January 2012 as a two-stage RFP, with first-phase responders down-selected to submit full proposals in the second phase. The Fort Carson microgrid will incorporate existing generation resources with large-scale renewable (solar) resources and battery backup (supplied in electric vehicles). The load that will be targeted for the Fort Carson demonstration will be a 2–3 MW critical load. The solar PV available on-base is approximately 2 MW. Key components of this phase are to include cyber-security considerations (a major stumbling block for other implemented microgrid efforts) and the design of a microgrid with very high penetration of renewable generation. Another key aspect is using vehicles as storage to accommodate the ramp-rate of the 2 MW PV array (which is technically owned by Morgan Stanley). The plan is to have base islandable. There is an effort to make charging stations for vehicles agree with SAE standards. It is a custom design for bidirectional charging that comes from TARDEC vehicles produced by Smith Electric. The installation also has 8–10 diesel generators of sizes 25 kW to 1.25 MW.

Fort Detrick: Existing 8 MW and 6.5 MW Type 2a microgrids. Study for a 10.3 MW Type 2a microgrid

There are two existing microgrids at Fort Detrick: at the signal corps area and at the central utility plant. The signal corps microgrid has existed since 1975 and is dedicated to and collocated with the mission, which is in a fenced area. Even though this is mission-dedicated capacity, Fort Detrick has started operating in a demand-response program through a third party, using a quarter of their 8 MW generation capacity (the peak mission load is around 2.5 MW), while still allowing n–1 redundancy with Fort Detrick’s generator sets. In the summer, the base frequently operates the microgrid in an islanded configuration. The mission requirements specify a 30-day supply of diesel fuel.

The second microgrid is also mission-specific. Privately owned-and-operated through an enhanced use lease, it provides steam, chilled water, and conditioned electric power to medical and research missions at the National Interagency Biodefense Campus. This microgrid is set up to provide 99.999% electrical reliability so that its normal operation can transition seamlessly to backup generation. The capacity is being expanded from 6–7 MW up to 16–17 MW, but due to the mission criticality, it is not available for backup power for the rest of the base or for cost-saving measures through demand-response or ancillary service markets. The base pays 21¢/kWh for electricity from this microgrid, as compared to 8¢/kWh for electricity from the utility.

Fort Detrick has also commissioned a study to look at a wider microgrid deployment on the installation, including the ability to link backup generator requirements in a way that is more reliable and cost-effective. The study recommended a 10.3 MW diesel-powered generator microgrid design which would allow long-term backup capability, whereas the individual building generators are designed for short-term operation. (Refueling trips for the 50+ building generators becomes an issue with tanks that have limited individual capacity.)

Fort Detrick also has ESTCP funding for an energy storage installation by SATCON and is investigating the possibility of a 10 MW solar PPA. Fort Detrick is an Army Net Zero installation.

Fort Devens: Study

A proposal based on a design by Sandia National Laboratories that will leverage an existing hydro plant was submitted to ESTCP.

Fort Sill: Underway 0.4 MW Type 1b microgrid

The 400 kW microgrid that is underway at Ft. Sill consists of two 210 kW diesel generators, 20 kW PV, 2.4 kW wind, and a 500 kVA battery bank. The goal is to island a cooling loop. Both generators are required to run this chiller loop; the loop is off in the winter (which makes meeting their testing milestones problematic). This project was funded out of recovery act funds.

Fort Wainwright: Existing 20 MW Type 1a microgrid

Ft. Wainwright in Alaska is an example of a Tinker AFB or Robins AFB-like energy agreement with the utility. The plant is a 20 MWe CHP plant that has recently been privatized.

Wheeler Army Airfield: Existing 0.225 MW Type 1b microgrid, a planned 2 MW Type 2b microgrid, and a planned 52 MW Type 2a microgrid

The existing microgrid at Wheeler Army Airfield (WAAF) is a microgrid put in by TARDEC as a prototype for a forward operating base and comprises three buildings, PV, along with vehicles for storage. The planned 2 MW effort would be with the local utility. They would control the generating source (2 MW) and some of the load (also 2 MW). There are plans for including 150 kW PV as well, but it was not clear if it will be able to operate in an islanded mode or not. The 2 MW generating source is for a water plant, and the source can connect with the microgrid and with the utility provider. The 52 MW microgrid would be similar to the Tinker AFB and Robins AFB agreements with WAAF and Schofield Barracks providing land so that the utility company could build a 52 MW generation unit. All current utility generation sources are steam units near the ocean, so diversity of sources would be increased with a generator away from the ocean. The local utility needs to go out with an RFP for building the generation units. If installed, the units will be bio-fuel compatible reciprocating diesels. The schedule is 2015–2016, but they are at the mercy of the public utility system for approval. WAAF consulted the legal agreements at Tinker and Robins to see what advice they can use regarding the land use agreement, but the installation will need approval from within the Army to proceed further.

NAVY

NSF Dahlgren: Existing 14 MW Type 2a microgrid

Naval Support Facility (NSF) Dahlgren, part of Naval Support Activity (NSA) South Potomac, is an installation within the Naval District Washington (NDW). NDW is developing a phased approach to increase their energy efficiency and energy security capabilities. Their plan is to increase energy security,

but to do so in a way that makes the most business sense. In implementing this plan, the first phase was to install and network together meters for electricity, natural gas, and hot water. The work started about two years ago with now approximately 200–300 devices at NSF Dahlgren, NSF Indian Head, and Washington Navy Yard. They are in the process of finishing the other 18 fencelines in NDW.

The second phase is to develop CONOPS so that energy management can be automated and scaled where it makes sense. There will be a tremendous increase in sensor data, but human operators will still play a critical role, making clear and consistent CONOPS an important aspect.

The third phase will be to allow the selective demand-response, load-shedding, or islanding of areas of an installation. NAVFAC (Naval Facilities Engineering Command) Washington has procedures that govern how transfer switches operate for switching between generation sources at a substation, so challenges may occur. At the moment, some switching at substations requires people to be on-site, but since the procedures are there to increase safety, it may be possible to implement this system with cameras instead.

To implement this three-phased approach, NDW has started by taking existing systems and networking them together in a cyber-secure manner. This has taken not just software, but hardware, too. This has been made easier by the fact that after September 2001 the Navy created a Public Safety Network (PSNet) that is used for Navy Public Safety operations in the CONUS area. The existence of this system meant that the smart meters can be integrated into an existing infrastructure.

At NSF Dahlgren, there has been a microgrid system for many years. Originally, the microgrid was implemented because of service reliability problems with the commercial utility (Dominion Virginia Power [DVP]). A cost analysis a decade ago showed that the lost revenue from power outages more than paid for the lease of generators from the NAVFAC Mobile Utilities Support Equipment program. The generators installed were in addition to the critical load generators that were required for specific Navy working capital programs. In implementing the microgrid, NSF Dahlgren has put in a Supervisory Control and Data Acquisition (SCADA) system as well as switching systems at substations, which are collocated with the generators. The generators are at the substations, not at individual buildings, allowing power to be used throughout the base, depending on the configuration of the substations. The microgrid is operated in two modes: to provide backup power to the facility if the utility grid goes down, and to operate in parallel with the utility grid to reduce load on the utility grid. The generators cannot back-feed power into the utility grid (in addition to the financial and safety complexities that this would introduce, there are technical aspects that would need to be solved).

Currently, all of their backup generation capacity is diesel-powered because, at the time of implementation, that was the option that made the most financial sense. As renewable energy and energy storage come down in price, NAVFAC and NDW would consider adding these to the microgrid since the infrastructure already exists. NAVFAC and NDW are interested in both the financial and energy security aspects and stated that one has to complement the other.

The cost calculations for the microgrid have also included different ways to interact with the utility market. The rate structure that the base formerly operated on made it economically attractive to use their

generation capacity in an active effort to reduce peaks in energy usage through peak-shaving. This rate structure has since changed, and they are currently enrolled in a demand-response program, where they can, and do, curtail power usage or start their own generators to reduce apparent demand. NSF Dahlgren currently has 14 MW of generation capacity enrolled in the demand-response program through a third-party, and they were called on several times last year to perform (which they did). The payments from the demand-response program cover the costs of the generator leases, showing that energy security can be enhanced in a cost-neutral way (dependent on which part of the country the installation is located).

One important aspect about cost, though, is that the cost equation could change, as Dominion Virginia Power is currently upgrading the single 34.5 kV feeder to the base so that there will be an additional 115 kV feeder line. If the base no longer loses power regularly and the availability of the demand-response program changes, the lease economics for the generators could change.

PMRF Barking Sands: Existing 1.5 MW Type 1a microgrid

1.5 MW of diesel generators run during critical operations to isolate the load from the utility service. The generators can connect and follow the utility signal before load is transferred for a seamless transition, but the length of time that parallel operation is allowed is limited by the utility.

Philadelphia Navy Yard: Study

A study was done by Sandia National Laboratories to come up with a design to combine the commercial, industrial, and residential demands at Philadelphia Navy Yard.

MARINES

Camp Smith: Study for a 15 MW Type 2b microgrid

The Smart Power Infrastructure Demonstration for Energy Reliability and Security (SPIDERS) JCTD is a multiphased joint effort to develop microgrids in a cyber-secure manner. SPIDERS is a collaboration between several of the DOE Laboratories with several organizations within the DoD, and is led by the U.S. Army Corps of Engineers. The effort is subdivided into three phases, with build-out efforts at Joint Base Pearl Harbor Hickam (JBPHH) (Phase 1), Fort Carson (Phase 2), and Camp Smith (Phase 3). The goal is to deploy or apply technology over legacy systems, looking at the technical feasibility as well as the business case and value proposition. Phases 2 and 3 are adding an element of cyber security to allow situational awareness and the ability to coordinate power demands with the utility provider.

The third phase of the SPIDERS program will be a microgrid at Camp Smith, Hawaii that is capable of operating the entire installation independently from the local utility in a cyber-secure manner. The precise details for this phase are still being formulated, but the current plan is to do a microgrid for the entire campus (~15 MW) with diesel generators, solar PV, and energy storage. The plan is dependent on FY 2013 funds, so it is not yet formalized. There have been serious power quality and power outage issues over the last six months.

MCAGCC Twentynine Palms: Existing 8.9 MW Type 2a microgrid. Underway 14.7 MW Type 2b microgrid

Marine Corps Air Ground Combat Center (MCAGCC) Twentynine Palms has an existing microgrid that operates daily, powered by a 7.2 MW CHP plant fueled by natural gas with diesel backup. It normally operates 24 hours a day/7 days a week, generating power in parallel with the local utility, Southern California Edison (SCE), to provide electricity and heat to the main power loop of the installation. It is directly tied in to one of the substations and has the ability to operate in an islanded mode, should the main feed for the installation go down. There is a requirement for seven days of backup diesel fuel, with diesel storage at the cogeneration plant and elsewhere on the base. During the course of this study, many changes to the MCAGCC Twentynine Palms microgrid have been in process. The description provided here was current as of February 2012, but the situation is still changing.

Switchover to islanded operation is currently performed manually at the control room of the CHP plant, but in the next couple of months (as of February 2012) it will transition to automatic switching at the substation. While operating in islanded mode, switches and breakers allow the main power loop to shed loads if demand exceeds generation, with additional switches currently being added.

There is also 3.2 MW of solar PV generation capacity operational on the base, distributed among approximately 30 individual building-level arrays, as well as with a 1.2 MW field that ties directly into the CHP plant substation. Additional PV of 1.3 MW is installed and awaiting SCE interconnection approval. The PV arrays can feed the CHP plant in the event of power loss from SCE and has been operationally tested in early 2012 with load-shedding plans implemented. There are more than 60 new switches to change power flows through the base and more than 140 buildings with Energy Management and Control System (EMCS) power management systems. Future plans call for more buildings with EMCS and tighter integration of those systems with the controls at the CHP plant. MCAGCC Twentynine Palms currently has about 80% of their buildings metered, which gives them insight into more than 75% of all electricity use. They are also adding natural gas, MBTU meters for hot water, and MBTU meters for cooling. Those meters will then tie back into the EMCS and the base-wide public works network.

The main feed from SCE is a single 34.5 kV line, but the installation is outgrowing the ability of that line to provide power, especially in the summer and with the significant expansion of the installation that is underway. SCE is installing redundant feeder lines to Twentynine Palms, with dual 115 kV lines, which will improve electrical service in the whole area, but that is still underway (with planned finish date of January 2013), with some permitting issues that have extended the timeline repeatedly. Upon completion, the installation will own the infrastructure at the substation.

In addition to the solar PV upgrade, the plan calls for installation of a second CHP plant (it will be a dual 4.6 MW turbine for a final output of 9.2 MW powered by natural gas with propane backup so that there will be more diversity of backup fuel), more PV (5.5 MW), the ability to control the power factor of the generation resources with a capacitor bank, and a large-scale battery back-up. There has been a 0.5 MW fuel cell in progress for several years, but it is not yet operational.

Also, GE is conducting a smart grid demonstration at four buildings to show controllability of five generators (range 20–150 kW) as part of a multiphase effort. Unfortunately, due to permitting problems, they cannot currently be used in load-shedding applications, but only in an emergency if the installation needs to operate in an islanded mode. Other efforts include improving the power factor control with capacitor banks; better control of supplies, loads, and load-shedding; and installation of a battery backup system.

The entire installation of Twentynine Palms consists of over 900 square miles of land area located in the high Mojave Desert of California. As such, the base is an attractive location for the large-scale implementation of renewable resources and is exploring the possibility of exporting excess power. This excess power would be provided through a power purchase agreement (PPA) to other Navy and Marine Corps facilities in southern California. It will take several years to work out but, if successful, will help to meet Federal and Navy renewable mandates.

MCAS Miramar: Planned 5.2 MW Type 2b microgrid

There is a planned microgrid at MCAS Miramar that will use available distributed energy resources. 3.2 MW landfill gas: the PPA needs to be set up in the correct way to allow the landfill gas system to participate in a microgrid operating in islanded mode. In addition to the landfill gas system, they are planning Cogen (1 MW) and solar PV (1 MW). In the event that the landfill gas approval does not go through, their campaign plan is to be net-zero by 2017. They were initially looking at 1 MW of battery storage as well, but this is just on paper at the moment. In the event of a power failure, everything starts as grid-tied, then all power would stop and disconnect from the utility grid, then black-start the islanded grid with the landfill gas system and distributed spot generators, then put power back to Miramar and start the Cogen system up, then add back the PV (California Rule 21 requires that PV systems stay disconnected from the grid until voltage and frequency are back within limits [106–127 V for 120 V basis and 59.3–60.5 Hz (inclusive)] and stable for a minute, then shut down generators. For the Cogen system, they are looking at natural gas and other fuels. They would like to be able to use the flight fuel as a secondary power generation source, as they have large quantities. If they have diesel as a backup, they are limited by emissions controls as to how many hours it could run in a year (although that limitation may not apply in the event of a grid failure – this was not completely clear to our contact). They don't really have a need for much more than 1 MW of Cogen, as there are only two places where they can use the heat: hot water for about 70 barracks and the absorption chillers.

JOINT BASES

Joint Base Lewis-McChord: Study

The goal of this study was to come up with a methodology to plan for an island. Islanding plan at JBLM was handed off to Pacific Northwest National Laboratory for a small demo. There is biomass potential at JBLM.

Joint Base Pearl Harbor-Hickam: Underway 2 MW Type 2b microgrid

The Smart Power Infrastructure Demonstration for Energy Reliability and Security (SPIDERS) JCTD is a multiphased joint effort to develop microgrids in a cyber-secure manner. SPIDERS is a collaboration between several of the DOE Laboratories with several organizations within the DoD, and is led by the U.S. Army Corps of Engineers. The effort is subdivided into three phases, with build-out efforts at Joint Base Pearl Harbor Hickam (JBPHH) (Phase 1), Fort Carson (Phase 2), and Camp Smith (Phase 3). The goal is to deploy or apply technology over legacy systems, looking at the technical feasibility as well as the business case and value proposition. Phases 2 and 3 are adding an element of cyber security to allow situational awareness and the ability to coordinate power demands with the utility provider.

JBPHH is the SPIDERS phase 1 location. This phase includes traditional generation coupled with small-scale renewable generation (solar and wind) to island a water treatment plant at JBPHH. The preliminary design for the microgrid includes two diesel generators supplying a maximum of 2.4 MW, 50 kW of vertical-axis wind turbine generation, and the potential to incorporate a hydrogen storage system and small-scale solar PV. The total critical load that is being serviced is approximately 650 kW. The initial microgrid had hydrogen as an energy storage mechanism, but that has had push-back. The recommended design for hydrogen was 65 kg H₂/day from an electrolyzer with about 100 kW from an H₂ fuel cell. A key component of this phase is to work with the Navy accreditation process, the DoD Information Assurance Certification and Accreditation Process (DIACAP) [31], and platform IT to ensure that equipment developed for the microgrid architecture is able to be used with all network infrastructures. If desired, all services have the opportunity to implement the same architecture by leveraging the Navy's accreditation approvals for the SmartGrid networks and system through the DoD's reciprocity memo [32]. The contract for Phase 1 was awarded in November 2011 to Burns & McDonnell Engineering Company.

Pohakuloa Training Area: Study

The Pohakuloa Training Area was the Army NetZero pilot project, but it is not one of the bases that was followed up with, as the proposal did not get funded. Also, in Hawaii, the interconnection of the renewables is challenging. The power company has limits on the system – only 10% of the peak feeder load can be renewable. The Army site is on their own feeder, so they are limited to 40 kW renewable (the peak at Pohakuloa is small, only 400 kW).

This page intentionally left blank.

APPENDIX B
FY 2012 ESTCP INSTALLATION ENERGY DEMONSTRATIONS:
MICROGRIDS [33]

EATON CORPORATION: DISTRIBUTED STORAGE INVERTER AND LEGACY GENERATOR INTEGRATION PLUS RENEWABLES SOLUTION FOR MICROGRIDS

Partners: U.S. Army ERDC-CERL; Electricore, Inc.

Demonstration Site: Fort Sill, Oklahoma

Description: This project will demonstrate the ability to operate a secure microgrid with natural gas generators and renewable energy sources without long-term battery energy storage. This microgrid solution will provide DoD with higher reliability and energy surety and minimize the needs for load dedicated costly storage.

PDE TOTAL ENERGY SOLUTIONS: SODIUM-METAL-HALIDE BATTERY ENERGY STORAGE FOR DOD INSTALLATIONS

Partners: GE Global Research/GE Energy Storage; Dynapower Corporation

Demonstration Site: Twentynine Palms, California

Description: This project is testing a Battery Energy Storage System (BESS) that incorporates utility grade power electronics, a step-up cast coil transformer, AC and DC switchgear, and sodium-metal-halide battery energy storage and is designed to integrate seamlessly to an existing microgrid. The project will demonstrate how a robust BESS will alleviate renewable energy intermittency, improve island-mode operations, and reduce demand charges and peak load stress on the main transformers and other grid equipment.

RAYTHEON-INTEGRATED DEFENSE SYSTEMS: ZINC BROMIDE FLOW BATTERY INSTALLATION FOR ISLANDING AND BACKUP POWER

Partners: Premium Power Corporation; NREL; NEI Contracting and Engineering, Inc.

Demonstration Site: Marine Corps Air Station Miramar, California

Description: This project integrates an innovative Zn/Br flow battery with a patented intelligent energy command and control technology to provide energy security, islanding capability, and reduced energy use. The demonstration will assess the operational life cycle cost of this technology to provide energy security.

SATCON TECHNOLOGY CORPORATION: GRID-INTERACTIVE RENEWABLE ENERGY GENERATION SYSTEM WITH DC-LINK BATTERY STORAGE INTEGRATION CAPABLE OF HYBRID MICROGRID OPERATION TO INCREASE ENERGY SECURITY ON DOD INSTALLATIONS

Partners: A123 Systems

Demonstration Sites: Fort Detrick, Maryland

Description: This project will demonstrate a hybrid electricity generation system that integrates DC-connected bulk energy storage with PV power sources to mitigate the inherent intermittency of the PV. The leveled AC power output will enhance installation energy security, reduce dependence on grid-supplied power, and reduce overall energy costs.

SIEMENS CORPORATION: INTEGRATED CONTROL FOR BUILDING ENERGY MANAGEMENT

Partners: Boeing Energy; KEMA Services, Inc.; University of California at Berkeley

Demonstration Sites: Naval Base Ventura County, California

Description: This project will demonstrate the functionality of an intelligent Building Energy Management System (iBEMS) for providing advanced, integrated control of building systems, dynamic demand response, and compatibility with microgrid central energy management. Key elements of iBEMS include Siemens Smart Energy Box, Local Energy Gateway, and advanced building control and energy management algorithms.

APPENDIX C

EPA DIESEL EMISSIONS STANDARDS

The Environmental Protection Agency (EPA)'s New Source Performance Standards (NSPS) specified emission requirements for stationary diesel engines [34]. Figure 42 lists the emissions regulations schedule.

Nonroad and stationary emissions regulations schedule

U.S. EPA Beginning January 1, 2007, (red bar) all stationary and nonroad regulations are harmonized.

kWM	(HP)	2004	2005	2006	2007	2008	2009	2010	2011	2012	2013	2014	2015	2016	2017
0 - 7	(0 - 10)		(7.5) / 8.0 / 0.80			(7.5) / 6.6 / 0.40									
8 - 18	(11 - 24)		(7.5) / 6.6 / 0.80			(7.5) / 6.6 / 0.40									
19 - 36	(25 - 48)		(7.5) / 5.5 / 0.60			(7.5) / 5.0 / 0.30					(4.7) / 5.0 / 0.03				
37 - 55	(49 - 74)		(7.5) / 5.0 / 0.40			(4.7) / 5.0 / 0.30				(4.7) / 5.0 / 0.03					
56 - 74	(75 - 99)					(4.7) / 5.0 / 0.40				3.3 / 0.19 / 5.0 / 0.02			0.40 / 0.19 / 5.0 / 0.02		
75 - 129	(100 - 173)		(6.6) / 5.0 / 0.30			(4.0) / 5.0 / 0.30				3.3 / 0.19 / 5.0 / 0.02			0.40 / 0.19 / 5.0 / 0.02		
130 - 224	(174 - 301)		(6.6) / 3.5 / 0.20			(4.0) / 3.5 / 0.20				2.0 / 0.19 / 3.5 / 0.02			0.40 / 0.19 / 3.5 / 0.02		
225 - 449	(302 - 602)		(8.4) / 3.5 / 0.20			(4.0) / 3.5 / 0.20				2.0 / 0.19 / 3.5 / 0.02			0.40 / 0.19 / 3.5 / 0.02		
450 - 560	(603 - 751)		(8.4) / 3.5 / 0.20			(4.0) / 3.5 / 0.20				2.0 / 0.19 / 3.5 / 0.02			0.40 / 0.19 / 3.5 / 0.02		
>560	(>751)		9.2 / 1.3 / 11.4 / 0.54			(6.4) / 3.5 / 0.20				3.5 / 0.40 / 3.5 / 0.10 0.67 / 0.40 / 3.5 / 0.10 (>1207hp) ^a			(3.5) / 0.19 / 3.5 / 0.04 0.67 / 0.19 / 3.5 / 0.03 (>751hp) ^b		

NO_x / HC / CO / PM (g/kW-hr)
(NO_x + HC) / CO / PM (g/kW-hr)
 [Conversion: (g/kW-hr) x 0.7457 = g/bhp-hr]
 Separate NO_x and HC standards separated by a slash.
 Combined NO_x and HC standards denoted in parentheses "()".

■ Tier 1
 ■ Tier 2
 ■ Tier 3
 ■ Tier 4 Interim
 ■ Tier 4 Final
a. Applies to portable power generation >1207hp. b. Applies to portable power generation >751hp.

Figure 42. EPA's emissions regulations schedule from NSPS [35].

Most commercially available generators on the market to date have Tier 2 emission levels. In the future, large stationary emergency generators (greater than 1 MW) can remain at Tier 2 emission levels. However, if the generators are to be used for non-emergency functions (such as peak shaving), these generators must satisfy Tier 4 emission regulations, which require 90% reduction in NO_x, HC, and PM.

In addition to the federal regulations from the EPA, state and local authorities can impose even more restrictive standards based on local air quality. Therefore, as we consider enrolling generators on demand-response programs, we must take into account the requirements of federal, state, and local authorities. As an example, in the state of Massachusetts, Tier 2 emergency generators are allowed to run 300 hours per year, which include monthly capacity tests, service to connected loads during utility outages, and voluntary peak shaving [36]. However, at the federal level, voluntary peak shaving is not considered emergency. In the future, generators enrolled in demand-response programs, including peak shaving, must be Tier 4 generators.

This page intentionally left blank.

REFERENCES

1. Constable, G., and Somerville, B. 2003. A Century of Innovation: Twenty Engineering Achievements that Transformed Our Lives, Joseph Henry Press, Washington, D.C.
2. U.S. Dept. of Energy, Office of Electric Transmission and Distribution. 2003. Grid 2030: A National Visions for Electricity's Second 100 Years.
<http://www.ferc.gov/eventcalendar/files/20050608125055-grid-2030.pdf>
3. Office of Electricity Deliver and Energy Reliability, Smart Grid R&D Program. 2011. DOE Microgrid Workshop Report, San Diego, CA.
<http://energy.gov/sites/prod/files/Microgrid%20Workshop%20Report%20August%202011.pdf>
4. AB32. 2006. Assembly Bill No. 32: California Global Warming Solutions Act of 2006, ed. California State Assembly, Sacramento, CA.
5. DoDI 8510.01. 2007. DoD Information Assurance Certification and Accreditation Process (DIACAP), ed. Department of Defense, pp. 53, Washington, D.C.
6. Department of Defense. 2009. DoD Information System Certification and Accreditation and Reciprocity. <http://www.doncio.navy.mil/PolicyView.aspx?ID=1209>
7. Warwick, W.M. 2002. A Primer on Electric Utilities, Deregulation, and Restructuring of U.S. Electricity Markets, U.S. Dept. of Energy, Washington, D.C.
<http://www1.eere.energy.gov/femp/pdfs/primer.pdf>
8. Kassakian, J., Schmalensee, R., et al. 2011. The Future of the Electric Grid, Massachusetts Institute of Technology Study. http://web.mit.edu/mitei/research/studies/documents/electric-grid-2011/Electric_Grid_Full_Report.pdf
9. Figure available at: http://www.nerc.com/docs/oc/rs/BubbleMap_2011-04-12.jpg
10. Ela, E., Milligan, M., and Kirby, B. 2011. Operating Reserves and Variable Generation: A comprehensive review of current strategies, studies, and fundamental research on the impact that increased penetration of variable renewable generation has on power system operating reserves. NREL/TP-5500-51978. Available online at:
http://www.nrel.gov/wind/systemsintegration/pdfs/2011/milligan_operating_reserves.pdf

11. Kirby, B. 2006. Demand Response for Power System Reliability: FAQ. ORNL/TM-2006/565. Available online at: <http://certs.lbl.gov/pdf/dr-for-psr-faq.pdf>
12. Potomac Economics. 2011. 2010 State of the Market Report for the MISO Electricity Markets. 149 pp., page xi. Available online at: <https://www.midwestiso.org/Library/Repository/Meeting%20Material/Stakeholder/BOD/Markets%20Committee/2011/20110714/20110714%20BOD%20Markets%20Committee%20Item%2005%20State%20of%20the%20Market%20Report%202010.pdf>. Accessed 3/26/2012.
13. Federal Energy Regulatory Commission. 2011. Frequency Regulation Compensation in the Organized Wholesale Power Markets, Order No. 755, 76 FR. 67260, FERC Stats. & Regs.
14. GAO. 2009. Defense Critical Infrastructure: Actions Needed to Improve the Consistency, Reliability, and Usefulness of DOD's Tier 1 Task Critical Asset List. GAO-09-740R. Available online at: <http://www.gao.gov/new.items/d09740r.pdf>
15. NDAA 2007. 2006. John Warner National Defense Authorization Act for Fiscal Year 2007. pp. 439. Washington, D.C.
16. Kwartin R., Alexander, S., Anderson, M., Clark, D., Collins, J., Lamson, C., et al. 2012. Solar Energy Development on Department of Defense Installations in the Mojave and Colorado Deserts, ed. Department of Defense, pp. 532.
17. 10 U.S.C. 2688. Utility Privatization Legislation text. Available online at: <http://www.acq.osd.mil/ie/energy/library/10USC2688.pdf>
18. Robyn, D. 2012. Statement of Dr. Dorothy Robyn, Deputy Under Secretary of Defense (Installations and Environment), Before the House Armed Services Committee Subcommittee on Readiness.
19. EPA. Nonroad Compression-Ignition Engines – Exhaust Emissions Standards. <http://www.epa.gov/otaq/standards/nonroad/nonroadci.htm>. Accessed 3/30/12.
20. Executive Office of the President, Office of Management and Budget. Memorandum for the Heads of Departments and Agencies, www.whitehouse.gov/omb
21. RSMeans Engineering Staff. 2011. Electrical Cost Data, Edition 34, RSMeans, publisher.
22. As discussed with Cummins, Joe Boss, Sales Engineer, meeting on January 13, 2012.

23. As discussed with EnerNOC, Christian Weeks, Senior Manager of Sales Operations, meeting on April 3, 2012.
24. Blomberg, S. 2011. Peak Shaving Feasibility Study. MIT Lincoln Laboratory.
25. Goodrich, A., James, T., and Woodhouse, M. 2012. Residential, Commercial, and Utility-Scale Photovoltaic System Prices in the United States: Current Drivers and Cost-Reduction Opportunities, NREL Technical Report, NRE/TP-6A20_53347.
26. Private communication with Zak Fardi, 1SolTech Company, 9/27/2011.
27. <http://www.nrel.gov/docs/fy09osti/46397.pdf>
28. A123 Presentation by Andy Chu, MIT Lincoln Laboratory, 11/30/2011.
29. National Climatic Data Center. <http://www.ncdc.noaa.gov/crn/products/html>
30. A123 Presentation by Andy Chu at MIT Lincoln Laboratory, 11/30/2011.
31. DoDI 8510.01. 2007. DoD Information Assurance Certification and Accreditation Process (DIACAP), ed. Department of Defense, pp. 53, Washington, D.C.
32. Department of Defense. 2009. DoD Information System Certification and Accreditation and Reciprocity. <http://www.doncio.navy.mil/PolicyView.aspx?ID=1209>
33. Obtained from the ESTCP program office website at: <http://www.serdp.org/News-and-Events/News-Announcements/Program-News/Department-of-Defense-announces-new-installation-energy-technology-demonstrations-for-FY-2012>. Accessed March 27, 2012.
34. EPA. Nonroad Compression-Ignition Engines – Exhaust Emissions Standards, <http://www.epa.gov/otaq/standards/nonroad/nonroadci.htm>. Accessed March 30, 2012.
35. Iverson, J. 2007. EPA emissions regulations. Technical Information from Cummins Power Generation.
36. Blomberg, S. 2011. Peak Shaving Feasibility Study. MIT Lincoln Laboratory.

This page intentionally left blank.

REPORT DOCUMENTATION PAGE			<i>Form Approved</i> <i>OMB No. 0704-0188</i>	
Public reporting burden for this collection of information is estimated to average 1 hour per response, including the time for reviewing instructions, searching existing data sources, gathering and maintaining the data needed, and completing and reviewing this collection of information. Send comments regarding this burden estimate or any other aspect of this collection of information, including suggestions for reducing this burden to Department of Defense, Washington Headquarters Services, Directorate for Information Operations and Reports (0704-0188), 1215 Jefferson Davis Highway, Suite 1204, Arlington, VA 22202-4302. Respondents should be aware that notwithstanding any other provision of law, no person shall be subject to any penalty for failing to comply with a collection of information if it does not display a currently valid OMB control number. PLEASE DO NOT RETURN YOUR FORM TO THE ABOVE ADDRESS.				
1. REPORT DATE (DD-MM-YYYY) 18 June 2012		2. REPORT TYPE Technical Report		3. DATES COVERED (From - To)
4. TITLE AND SUBTITLE Microgrid Study: Energy Security for DoD Installations			5a. CONTRACT NUMBER FA8721-05-C-0002	
			5b. GRANT NUMBER	
			5c. PROGRAM ELEMENT NUMBER	
6. AUTHOR(S) S.B. Van Broekhoven, N. Judson, S.V.T. Nguyen, and W.D. Ross			5d. PROJECT NUMBER 2140	
			5e. TASK NUMBER 22	
			5f. WORK UNIT NUMBER	
7. PERFORMING ORGANIZATION NAME(S) AND ADDRESS(ES) MIT Lincoln Laboratory 244 Wood Street Lexington, MA 02420-9108			8. PERFORMING ORGANIZATION REPORT NUMBER TR-1164	
9. SPONSORING / MONITORING AGENCY NAME(S) AND ADDRESS(ES) Environmental Security Technology Certification Program (ESTCP) 901 North Stuart Street, Suite 303 Arlington, VA 22203			10. SPONSOR/MONITOR'S ACRONYM(S)	
			11. SPONSOR/MONITOR'S REPORT NUMBER(S) ESC-EN-HA-TR-2012-103	
12. DISTRIBUTION / AVAILABILITY STATEMENT Approved for public release; distribution is unlimited.				
13. SUPPLEMENTARY NOTES				
14. ABSTRACT Growing concerns about the vulnerability of the electric grid, uncertainty about the cost of oil, and an increase in the deployment of renewable generation on domestic military installations have all led the Department of Defense (DoD) to reconsider its strategy for providing energy security for critical domestic operations. Existing solutions typically use dedicated backup generators to service each critical load. For large installations, this can result in over 50 small generators, each servicing a low voltage feeder to an individual building. The system as a whole is typically not well integrated either internally, with nearby renewable assets, or to the larger external grid. As a result, system performance is not optimized for efficient, reactive, and sustainable operations across the installation in the event of a power outage or in response to periods of high stress on the grid. Recent advances in energy management systems and power electronics provide an opportunity to interconnect multiple sources and loads into an integrated system that can then be optimized for reliability, efficiency, and/or cost. These integrated energy systems, or microgrids , are the focus of this study. The study was performed with the goals of (1) achieving a better understanding of the current microgrid efforts across DoD installations, specifically those that were in place or underway by the end of FY11, (2) categorizing the efforts with a consistent typology based on common, measurable parameters, and (3) performing cost-benefit trades for different microgrid architectures. This report summarizes the results of several months of analysis and provides insight into opportunities for increased energy security, efficiency, and the incorporation of renewable and distributed energy resources into microgrids, as well as the factors that might facilitate or impede implementation.				
15. SUBJECT TERMS				
16. SECURITY CLASSIFICATION OF:			17. LIMITATION OF ABSTRACT Same as report	18. NUMBER OF PAGES 100
a. REPORT Unclassified	b. ABSTRACT Unclassified	c. THIS PAGE Unclassified		
			19b. TELEPHONE NUMBER (include area code)	

