

FAA-RD-74-62

**Project Report  
ATC-30, I**

# **Provisional Signal Formats for the Discrete Address Beacon System, Revision I**

**P. Drouilhet, Editor**

**25 April 1974**

---

**Lincoln Laboratory**  
MASSACHUSETTS INSTITUTE OF TECHNOLOGY  
*LEXINGTON, MASSACHUSETTS*

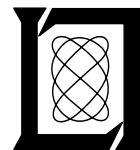

---

Prepared for the Federal Aviation Administration,  
Washington, D.C. 20591

This document is available to the public through  
the National Technical Information Service,  
Springfield, VA 22161

**This document is disseminated under the sponsorship of the Department of Transportation in the interest of information exchange. The United States Government assumes no liability for its contents or use thereof.**

## PREFACE

The Discrete Address Beacon System (DABS) will provide an evolutionary upgrading of air traffic surveillance capability together with an integrated ground/air data link. Both features are required to support the planned automation of air traffic control.

DABS includes a unique code as part of each interrogation to indicate to which aircraft that interrogation is addressed. This scheme allows the ground sensor to control the timing of replies from neighboring aircraft, eliminating the self-interference due to overlapping replies (termed synchronous garble) which is a basic limitation of the present Air Traffic Control Radar Beacon System (ATCRBS). By providing for the inclusion of a message as part of an interrogation and/or reply, ground/air data link communications can be accommodated on the same channel with a small increase in equipment complexity. In addition to its surveillance and communications functions, DABS provides the basis for a number of additional ATC-related functions including air-to-air conflict detection, precise synchronization of airborne clocks, and one-way DME [1].

Two issues have dominated the design of DABS: the ability to meet the projected surveillance and communications demands of an automated ATC system; and cost, both to the FAA and to the airspace user, including the cost of transitioning from ATCRBS to DABS.

Reliability of service, in terms of surveillance continuity and communications availability, has received greater emphasis than accuracy or data rate. Such reliability assumes special importance in supporting an automated system, where a human controller is not readily available to interpret imperfect data and work around system vagaries.

A gradual evolution from ATCRBS to DABS is required to allow for a reasonable service life for ATCRBS equipments before mandatory replacement. ATCRBS and DABS sensors and transponders will thus coexist for an extended period of time. To preclude the expense of introducing a new system while maintaining an old one at full capability, DABS equipments must include ATCRBS capability. Then during the transition DABS sensors will provide surveillance of ATCRBS-equipped aircraft, and DABS-equipped aircraft will respond to ATCRBS sensors. While there are many possible approaches to the design of a discrete address beacon system, the need for inter-operation with ATCRBS dictates maximum commonality of design consistent with achieving the desired system performance

The major criteria influencing the design of DABS signal formats are as follows:

- i. Minimize system (especially transponder) cost commensurate with performance requirements.
- ii. Provide for the easy inclusion of ATCRBS as a mode of DABS.
- iii. Maximize air/ground link reliability, with particular emphasis on minimizing degradation due to ATCRBS interference, multipath, and fading arising from antenna pattern irregularities.
- iv. Provide surveillance and communication capacity to meet projected demands, with enough margin and design flexibility to accommodate reasonable unforeseen requirements.

The selection of signal formats, finally embodied in a National Standard for DABS, will be the most enduring - and thus the most important - element of the DABS design. Particular realizations of sensors and transponders, while an integral part of demonstrating system viability, can be supplanted as hardware technology evolves without affecting already existing equipments. A change in signal format would have a much greater impact.

Therefore, much emphasis has been given to "getting it right" the first time, and to providing sufficient flexibility to allow for future growth of DABS applications.

This document specifies provisional DABS signal formats, i. e., the characteristics of the "signals-in-space" which form the DABS interrogations and replies. Also included is a discussion of the utilization of the described formats to effect the surveillance and data link communication functions for which DABS has been designed. These signal formats will be used in the design and construction of engineering development model transponders and interrogators for prototype system test and evaluation at NAFEC during Phase II of the DABS Development Program; and, with modifications resulting from this test and evaluation effort, will form the basis for the operational implementation of DABS.



## TABLE OF CONTENTS

Section	Page
PREFACE. . . . .	iii
1. INTRODUCTION/SUMMARY . . . . .	1
1.1 General . . . . .	1
1.2 ATCRBS Compatibility . . . . .	1
1.3 Uplink Parameters . . . . .	2
1.4 Downlink Parameters. . . . .	3
1.5 Modified ATCRBS Interrogation Types. . . . .	3
1.6 DABS Interrogation Types . . . . .	3
1.7 DABS Reply Types . . . . .	4
1.8 Extended-Length Messages. . . . .	4
1.9 Auxiliary Functions. . . . .	5
2. INTERROGATION SIGNAL CHARACTERISTICS . . . . .	6
2.1 General . . . . .	6
2.2 Operating Frequency . . . . .	6
2.3 ATCRBS/DABS All-Call Interrogation Signal Characteristics . . . . .	6
2.4 DABS Interrogation Signal Characteristics. . . . .	8
2.5 DABS SLS. . . . .	9
3. REPLY SIGNAL CHARACTERISTICS . . . . .	11
3.1 General . . . . .	11
3.2 Operating Frequency . . . . .	11
3.3 ATCRBS Reply Signal Characteristics . . . . .	11
3.4 DABS Reply Signal Characteristics . . . . .	12
3.5 Reply Delay and Jitter for a DABS Interrogation. . . . .	13
3.6 Reply Delay and Jitter for an ATCRBS/DABS All-Call Interrogation . . . . .	13
4. DABS INTERROGATION AND REPLY MESSAGE FORMATS . . . . .	14
4.1 General . . . . .	14
4.2 Interrogation types . . . . .	14

## CONTENTS (Continued)

<u>Section</u>	<u>Page</u>
4.3 Reply Types . . . . .	15
4.4 Data Block Formats . . . . .	16
5. ERROR PROTECTION . . . . .	28
5.1 Error Protection Technique . . . . .	28
5.2 Parity Check Sequence Generation . . . . .	29
5.3 Address/Parity Combination . . . . .	30
5.4 Encoder Operation . . . . .	30
6. LINK OPERATING PROTOCOL . . . . .	32
6.1 Surveillance . . . . .	32
6.2 Ground-to-Air Comm-A Data Link Message Transfer . . . . .	35
6.3 Air-to-Ground Comm-B Data Link Message Transfer . . . . .	39
6.4 Comm-C/Comm-D Extended-Length Message Protocol . . . . .	41
7. DISCRETE ADDRESS CODE ASSIGNMENT . . . . .	46
7.1 General. . . . .	46
7.2 Recommended Code Assignment Procedure . . . . .	47
REFERENCES . . . . .	49

## LIST OF ILLUSTRATIONS

<u>Figure</u>	<u>Page</u>
2.3-1 . . . . .	7
2.4-1 . . . . .	8
3.3-1 . . . . .	11
3.4-1 . . . . .	12
4.4-1 . . . . .	18
5.4-1 . . . . .	30
6.2-1 . . . . .	38



## 1. INTRODUCTION/SUMMARY

### 1.1 General

DABS adds to ATCRBS the capability for selectively interrogating individual aircraft and for exchanging data-link messages between the interrogator facility and the aircraft. These new capabilities require the introduction of new signal formats and operating modes. The principal features of the DABS formats are summarized in this section; later sections amplify on each of these issues, providing a detailed description of the formats and the related operating modes.

### 1.2 ATCRBS Compatibility

To facilitate the transition from ATCRBS to DABS over an extended period, DABS installations, both ground and airborne, include full ATCRBS capability: using ATCRBS formats, DABS interrogators will provide surveillance of ATCRBS-equipped aircraft and DABS transponders will reply to ATCRBS interrogators. To accomplish this dual mode operation (ATCRBS and DABS) with minimum equipment complexity, DABS will operate on the same interrogation and reply frequencies as ATCRBS.

#### 1.2.1 Discrete Address

Each DABS-equipped aircraft will be assigned a unique 24-bit address, which will be included in all discretely-addressed interrogations and replies involving that aircraft. This address can be assigned in such a manner as to automatically identify to the ground facility the voice call sign of the aircraft.

#### 1.2.2 Error Protection

Each DABS interrogation/reply is encoded to reduce to a very small value the probability of acceptance of a message containing an error. Twenty-

four redundant check-bits (parity bits) are included in each message. These check-bits are combined with the 24 address bits so that a high degree of error protection is achieved with no increase in message length.

### 1.2.3 Message Length

A DABS message (interrogation or reply) is either 56 or 112 bits long, inclusive of address/parity bits, but excluding synchronization preamble. The 112-bit format is used for the transmission of ground-to-air or air-to-ground data link messages.

### 1.2.4 Altitude Echo

Each DABS interrogation (except ELM, paragraph 1.8) contains a 12-bit field which transmits to the aircraft the latest received value of the aircraft altitude, corrected for local barometric pressure. This provides a continuous, full-loop check of the aircraft's altitude-reporting system, a necessity if the surveillance data are to be used for automatic conflict detection/resolution.

### 1.2.5 Synchro-DABS

The DABS formats include the necessary control information to accommodate the auxiliary functions of the proposed Synchro-DABS system [1]. These functions include air-to-air conflict detection, precise synchronization of airborne clocks, and one-way DME. (See paragraph 1.9.)

## 1.3 Uplink Parameters

1.3.1 Frequency: 1030 MHz (same as ATCRBS).

1.3.2 Modulation: 4 Mb/sec differential phase-shift keying (DPSK).

1.3.3 ATCRBS Reply Suppression

Each discretely-addressed uplink transmission is preceded by a pair of 0.8  $\mu$ sec pulses, spaced 2.0  $\mu$ sec apart. This pulse pair activates the side-lobe suppression circuitry in an ATCRBS transponder, preventing the DABS transmission from triggering an accidental reply from the ATCRBS transponder.

The duration of a DABS uplink transmission is less than the minimum ATCRBS SLS suppression time, so that the DABS transmission is completed before the ATCRBS transponder comes out of suppression.

#### 1.4 Downlink Parameters

1.4.1 Frequency: 1090 MHz (same as ATCRBS)

1.4.2 Modulation: 1 Mb/sec pulse position modulation (PPM). (A form of nonreturn-to-zero pulse-amplitude modulation (NRZ/PAM) which permits the demodulation of the DABS signal in the presence of strong ATCRBS interference.)

#### 1.5 Modified ATCRBS Interrogation Types

##### 1.5.1 ATCRBS/DABS All-Call (Mode A)

A modified ATCRBS Mode A interrogation which elicits a normal Mode A reply from an ATCRBS transponder, and an All-Call reply from a DABS transponder not being discretely addressed.

##### 1.5.2 ATCRBS/DABS All-Call (Mode C)

A modified ATCRBS Mode C interrogation which elicits a normal Mode C reply from an ATCRBS transponder, and an All-Call reply from a DABS transponder.

#### 1.6 DABS Interrogation Types

##### 1.6.1 DABS-Only All-Call

A special 56-bit format which elicits an All-Call reply from a DABS transponder, but elicits no reply from an ATCRBS transponder.

##### 1.6.2 Surveillance

A 56-bit format which contains a control field, a special data field (usually altitude echo), and the 24-bit address/parity field.

### 1.6.3 Comm-A

A 112-bit format which, in addition to the contents of the Surveillance interrogation, contains a 56-bit data link field.

### 1.6.4 Comm-C

A special 112-bit format which is used for Extended-Length Message (ELM) transmissions.

## 1.7 DABS Reply Types

### 1.7.1 All-Call

A 56-bit format used in response to an ATCRBS/DABS All-Call or DABS-only All-Call interrogation; it includes a 6-bit "capability" field, plus 24-bit aircraft address and parity fields.

### 1.7.2 Surveillance

A 56-bit format which contains a control field, altitude (or 4096 code setting), and address/parity field.

### 1.7.3 Comm-B

A 112-bit format which, in addition to the contents of a Surveillance reply, contains a 56-bit data link field.

### 1.7.4 Comm-D

A special 112-bit format which is used for Extended-Length Message transmissions.

## 1.8 Extended-Length Messages

The Comm-A and Comm-B formats provide for the inclusion of a 56-bit data link message as part of an interrogation or reply. Each such message requires a full interrogation-reply pair for its transmission, and is individually acknowledged. An Extended-Length Message (ELM) protocol with associated up- and downlink formats (Comm-C and Comm-D) provides for the

more efficient transmission of longer messages. This protocol permits the chaining of up to 16 message segments, each a Comm-C or Comm-D format containing 80 data link message bits, with a single acknowledgment for the total message. It is expected that ELM capability will be included only in relatively sophisticated airborne installations, e. g., air carrier aircraft, and will share input/output devices with other onboard data link systems.

## 1.9 Auxiliary Functions

Once each scan of the interrogator antenna, a precisely-timed interrogation will be transmitted to each DABS-equipped aircraft. This synchronized interrogation is timed such that the resulting reply occurs at a specified clock time. These synchronized interrogations and replies provide the basis for several auxiliary functions, as follows:

### 1.9.1 Air-to-Air Conflict Detection

Suitably-equipped aircraft can determine the range, range-rate, and relative bearing of other DABS-equipped aircraft by listening to their synchronized replies, and thus can perform air-to-air conflict detection.

### 1.9.2 Clock Synchronization

The synchronized reply time provides to the aircraft a precise time reference once every few seconds. This can be used to continuously update an airborne clock, permitting the maintenance of a precise on-board time standard at relatively low cost.

### 1.9.3 One-way DME

Ground facilities (e. g., VOR's) can be equipped to radiate DABS-like signals at precise clock times. These signals can be used by aircraft equipped with DABS plus a time reference and distance measuring decoder to determine the range to the radiating ground facility. (See 6.2.5.)

## 2. INTERROGATION SIGNAL CHARACTERISTICS

### 2.1 General

Two classes of interrogations are normally transmitted by a DABS sensor: (a) ATCRBS/DABS All-Call interrogations, and (b) DABS interrogations. ATCRBS/DABS All-Call interrogations are used for surveillance of ATCRBS-equipped aircraft and for simultaneous acquisition of DABS-equipped aircraft. DABS interrogations are used for surveillance and data link communications with DABS-equipped aircraft on a sensor's surveillance roll-call; in addition, the DABS-only All-Call may be used, if needed, for the initial acquisition of DABS aircraft without triggering replies from ATCRBS-equipped aircraft.

### 2.2 Operating Frequency

The carrier frequency of the interrogation transmission shall be  $1030 \pm 0.01$  MHz.

### 2.3 ATCRBS/DABS All-Call Interrogation Signal Characteristics

The ATCRBS/DABS All-Call interrogations are similar to the corresponding ATCRBS interrogations as defined in the U.S. National Standard for the IFF Mark-X (SIF)/Air Traffic Control Radar Beacon System Characteristics, but with an additional pulse  $P_4$  following  $P_3$ . An ATCRBS transponder will be unaffected by the presence of the  $P_4$  pulse, and will respond with a normal ATCRBS reply. A DABS transponder will recognize the interrogation as a DABS All-Call interrogation and will respond with a DABS All-Call reply.

2.3.1 An ATCRBS/DABS All-Call interrogation consists of three pulses,  $P_1$ ,  $P_3$ , and  $P_4$ , as depicted in Fig. 2.3-1. Following the first interrogation pulse  $P_1$ , a control pulse  $P_2$  is transmitted using a separate antenna pattern to suppress responses from aircraft in the sidelobes of the interrogator antenna.

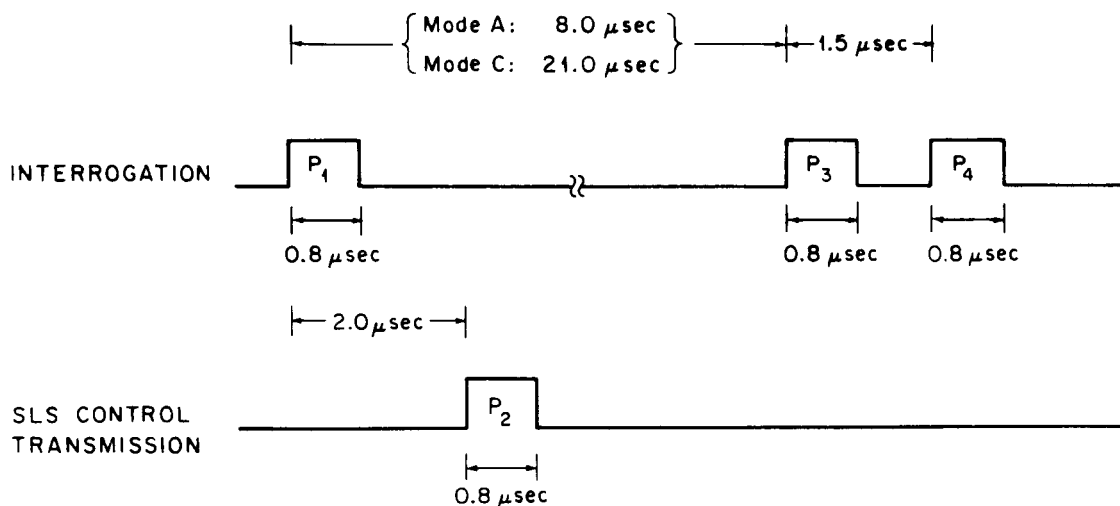

Fig. 2.3-1. ATCRBS/DABS All-Call interrogations.

2.3.2 Pulse width, spacing, rise and fall times, and tolerances thereon for pulses  $P_1$ ,  $P_2$ , and  $P_3$  shall be as defined in the U.S. National Standard for ATCRBS.

2.3.3 The interval between  $P_3$  and  $P_4$  shall be  $1.5 \pm 0.1 \mu\text{sec}$ .

2.3.4 The duration of pulse  $P_4$  shall be  $0.8 \pm 0.1 \mu\text{sec}$ .

2.3.5 The rise time and fall time of pulse  $P_4$  shall be as defined in the U.S. National Standard for ATCRBS for pulses  $P_1$ ,  $P_2$ , and  $P_3$ .

2.3.6 The radiated amplitude of  $P_4$  shall be within 1 dB of the radiated amplitude of  $P_1$ .

2.3.7 The radiated amplitudes of  $P_2$  and  $P_3$  compared to  $P_1$  shall be as defined in the U.S. National Standard for ATCRBS.

2.3.8 The carrier frequencies of  $P_1$ ,  $P_2$ , and  $P_3$  shall not differ from each other by more than 0.2 MHz.

## 2.4 DABS Interrogation Signal Characteristics

A DABS interrogation consists of a preamble and a data block containing 56 or 112 data bits. The signal format is depicted in Fig. 2.4-1.

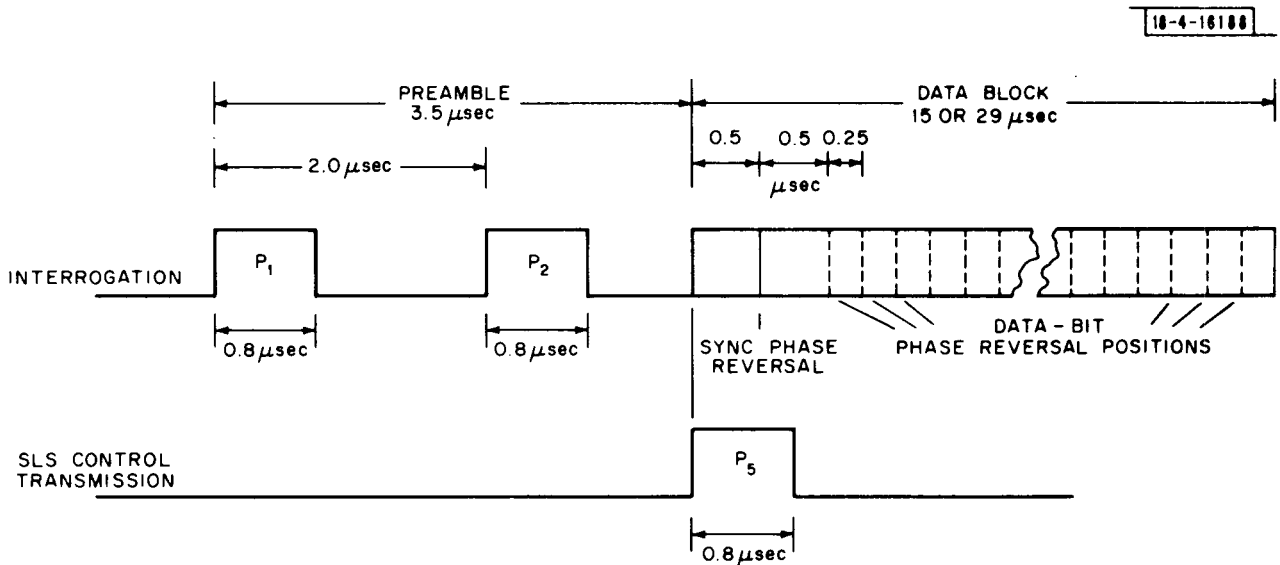

Fig. 2.4-1. DABS interrogation.

### 2.4.1 Preamble

The preamble consists of a pair of pulses P<sub>1</sub> and P<sub>2</sub>, spaced  $2.0 \pm 0.1 \mu\text{sec}$  apart, to intentionally suppress ATCRBS transponders which receive the interrogation. Pulse width and rise and fall times shall be as defined for pulses P<sub>1</sub> and P<sub>2</sub> of an ATCRBS interrogation.

2.4.2 The data block consists of a single RF pulse of duration 15 or 29 μsec beginning  $3.5 \pm 0.1 \mu\text{sec}$  after the leading edge of P<sub>1</sub>. Data modulation is accomplished by phase reversals of the RF signal.

2.4.3 The rise and fall times of the RF carrier pulse for the data block shall be as defined for pulses P<sub>1</sub>, P<sub>2</sub>, and P<sub>3</sub> of an ATCRBS interrogation.



2.4.4 The radiated amplitude of  $P_2$  and the data block shall be within 1 dB of the radiated amplitude of  $P_1$ .

2.4.5 A phase reversal, termed the sync phase reversal, shall occur  $0.5 \pm 0.1$   $\mu\text{sec}$  following the leading edge of the data block.

2.4.6 Each data block includes 56 or 112 data bits, each of 0.25  $\mu\text{sec}$  duration. The first data bit begins 0.5  $\mu\text{sec}$  after the sync phase reversal.

2.4.7 Differential Phase Shift Keyed (DPSK) modulation is used, with a phase reversal of the RF signal at the beginning of a bit interval representing a binary one, and no phase reversal representing a binary zero.

2.4.8 Each transmitted phase reversal shall occur at a time  $N \times 0.25 \pm 0.02$   $\mu\text{sec}$  ( $N \geq 2$ ) after the sync phase reversal. Thus, the first time a data bit phase reversal can occur is  $0.5 \pm 0.02$   $\mu\text{sec}$  after the sync phase reversal.

2.4.9 The time required for a phase reversal of the transmitted signal shall be not less than 0.04  $\mu\text{sec}$ , nor greater than 0.08  $\mu\text{sec}$ , as measured by the spacing between the 90% points of the amplitude transient associated with each phase reversal.

2.4.10 The tolerance on the phase relationship between successive data bits in the DPSK signal shall be  $\pm 5^\circ$ .

## 2.5 DABS SLS

2.5.1 A control pulse  $P_5$  shall be transmitted to permit the DABS transponder to determine whether the interrogation emanates from the main beam or a side-lobe of an interrogator.

2.5.2 The control pulse  $P_5$  shall be  $0.8 \pm 0.1$   $\mu\text{sec}$  long. The leading edge of pulse  $P_5$  shall be coincident in time,  $\pm 0.05$   $\mu\text{sec}$ , with the leading edge of the data block. The rise time and fall time of pulse  $P_5$  shall be as defined for pulses  $P_1$ ,  $P_2$  and  $P_3$  of an ATCRBS interrogation.

2.5.3 The control pulse  $P_5$  shall be radiated using the same antenna pattern used for the  $P_2$  control pulse of an ATCRBS/DABS All-Call interrogation. For an aircraft not in the main beam of the interrogator, the received  $P_5$  pulse amplitude will exceed that of the data block. The transponder will then not detect the sync phase reversal, and thus will not attempt to decode the remainder of the data block.

2.5.4 The carrier frequencies of  $P_5$  and the DABS data block shall not differ from each other by more than 0.1 MHz.

### 3. REPLY SIGNAL CHARACTERISTICS

#### 3.1 General

Two classes of replies are generated by a DABS transponder:  
(a) ATCRBS replies (Mode A or Mode C), and (b) DABS replies. ATCRBS replies are generated in response to normal ATCRBS interrogations. DABS replies are generated in response to ATCRBS/DABS All-Call interrogations or DABS interrogations.

#### 3.2 Operating Frequency

The carrier frequency of the reply transmission shall be  $1090 \pm 3$  MHz.

#### 3.3 ATCRBS Reply Signal Characteristics

In response to an ATCRBS Mode A or Mode C interrogation, a DABS transponder shall generate the appropriate Mode A or Mode C ATCRBS reply, as defined in the U.S. National Standard for ATCRBS. The reply signal characteristics are depicted in Fig. 3.3-1. Reply pulse length, interval, and tolerances thereon are as defined in the U.S. National Standard for ATCRBS.

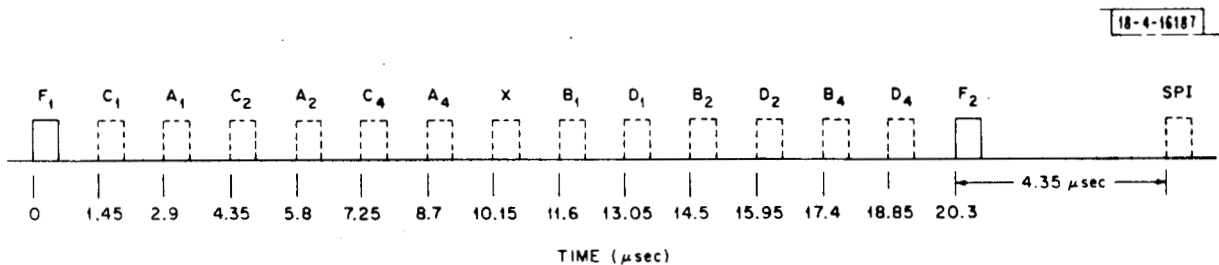

Fig. 3.3-1. ATCRBS reply format.

### 3.4 DABS Reply Signal Characteristics

A DABS reply consists of a preamble and a data block containing 56 or 112 data bits. The signal format is depicted in Fig. 3.4-1.

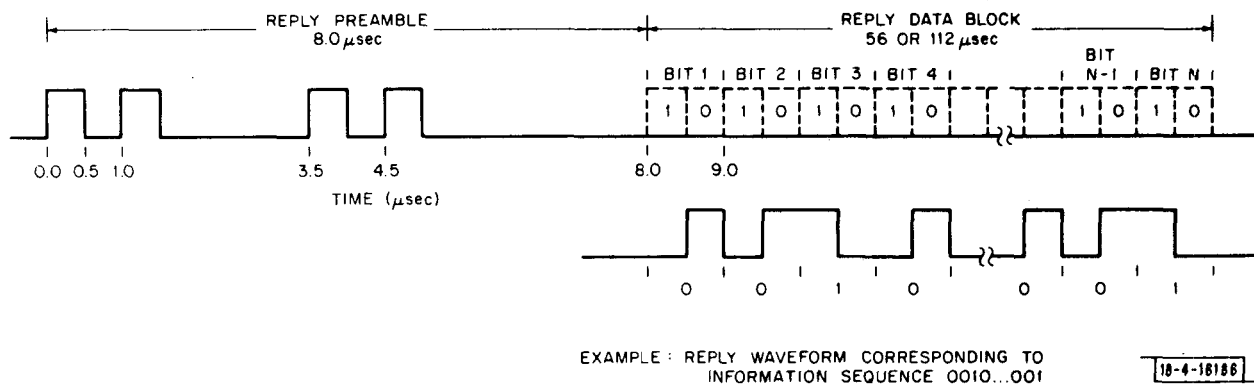

Fig. 3.4-1. DABS reply format.

#### 3.4.1 Preamble

The preamble consists of a series of four 0.5 μsec pulses. The intervals between the leading edge of the first preamble pulse and the leading edges of the second, third, and fourth preamble pulses shall be 1.0, 3.5, and 4.5 μsec, respectively.

#### 3.4.2 Data Block

The data block begins 8.0 μsec following the leading edge of the first preamble pulse. Binary data are transmitted at a 1.0 Mb/sec data rate using pulse position modulation (PPM) as follows: in the 1.0 μsec interval corresponding to each data bit, a 0.5 μsec pulse is transmitted in the first half of the interval if the data bit is a 1, and in the second half of the interval if the data bit is a 0.

### 3.4.3 Reply Pulse Shape

All reply pulses shall have a pulse duration of  $0.5 \pm 0.05 \mu\text{sec}$ , except that when a 1 follows a 0 in the data block the two  $0.5 \mu\text{sec}$  pulses are contiguous, resulting in a single pulse of duration  $1.0 \pm 0.05 \mu\text{sec}$ . Pulse rise time shall be between  $0.05$  and  $0.1 \mu\text{sec}$ , and pulse fall time shall be between  $0.05$  and  $0.2 \mu\text{sec}$ . The pulse amplitude variation of one pulse with respect to any other pulse in a reply train shall not exceed 1 dB.

Note: The intent of the lower limit of rise and fall times ( $0.05 \mu\text{sec}$ ) is to reduce the sideband radiation. Equipment will meet this requirement if the sideband radiation is no greater than that which theoretically would be produced by a trapezoidal wave having the stated rise and decay times.

### 3.4.4 Reply Pulse Interval Tolerances

The pulse interval tolerance for the leading edge of each pulse, with respect to the leading edge of the first preamble pulse of the reply, shall be  $\pm 0.05 \mu\text{sec}$ .

### 3.5 Reply Delay and Jitter for a DABS Interrogation

The leading edge of the first preamble pulse of the reply to a DABS interrogation shall occur at a time  $128.0 \pm 0.25 \mu\text{sec}$  following the sync phase reversal of the interrogation data block. The jitter of the reply delay shall not exceed  $0.05 \mu\text{sec}$ , rms.

### 3.6 Reply Delay and Jitter for an ATCRBS/DABS All-Call Interrogation

The leading edge of the first preamble pulse of the reply to an ATCRBS/DABS All-Call interrogation shall occur at a time  $128.0 \pm 0.25 \mu\text{sec}$  following the leading edge of the  $P_4$  pulse of the interrogation. The jitter of the reply delay shall not exceed  $0.06 \mu\text{sec}$ , rms. (This value is consistent with the ATCRBS National Standard reply jitter specification of  $\pm 0.1 \mu\text{sec}$ .)

## 4. DABS INTERROGATION AND REPLY MESSAGE FORMATS

### 4.1 General

There are four DABS interrogation types, and four DABS reply types, as follows:

#### Interrogation Types

DABS-Only All-Call

Surveillance - (synchronized or unsynchronized)

Comm-A - (synchronized or unsynchronized)

Comm-C

#### Reply Types

All-Call

Surveillance - (synchronized or unsynchronized)

Comm-B - (unsynchronized)

Comm-D

### 4.2 Interrogation Types

4.2.1 The DABS-Only All-Call interrogation (length 56 bits) is used for the acquisition of DABS-equipped aircraft. It is used in place of the ATCRBS/DABS All-Call interrogation when the interrogator does not desire to elicit replies from ATCRBS-equipped aircraft.

#### 4.2.2 Surveillance Interrogation

The Surveillance interrogation (length 56 bits) is the normal DABS interrogation. It is used for a surveillance update when no data link message is to be transmitted.

#### 4. 2. 3 Comm-A Interrogation

The Comm-A interrogation (length 112 bits) is used for the transmission of a 56-bit ground-to-air data link message. Longer messages may be accommodated by successive interrogation-response cycles. The Comm-A interrogation includes the capabilities of the Surveillance interrogation, and thus may be used in its place for a surveillance update.

#### 4. 2. 4 Comm-C Interrogation

The Comm-C interrogation (length 112 bits) is used for the more efficient transmission of long ground-to-air data link messages. Each Comm-C interrogation includes an 80-bit message field, and up to 16 Comm-C interrogations may be acknowledged with a single transponder reply. A Comm-C interrogation cannot be used for a surveillance update.

### 4. 3 Reply Types

#### 4. 3. 1 All-Call Reply

The All-Call reply (length 56 bits) is used in response to an ATCRBS/DABS All-Call or a DABS-Only All-Call interrogation. Its function is to inform the interrogator of the presence of a DABS-equipped aircraft within its area of coverage. It includes the aircraft's discrete address code so that the interrogator can add the aircraft to its DABS target roll-call and discretely address subsequent interrogations to the aircraft. In addition, it includes a "Capability Field" to designate the data link input/output capability of the aircraft.

#### 4. 3. 2 Surveillance Reply

The Surveillance reply (length 56 bits) is the normal DABS reply when no air-to-ground data-link transmission is required. This reply normally includes the aircraft pressure altitude, digitally encoded in the same format used for an ATCRBS Mode C reply. However, under interrogator control the pressure altitude transmission may be replaced by the aircraft's ATCRBS identity (4096) code setting. This code readout is initiated by the interrogator, e. g., on initial acquisition of a DABS-equipped target, but also may be requested by the aircraft, e. g., to designate an emergency condition.

### 4.3.3 Comm-B Reply

The Comm-B reply (length 112 bits) is used for the transmission of a 56-bit air-to-ground data link message. Longer messages may be accommodated by successive interrogation-response cycles. The Comm-B reply includes the capabilities of the (unsynchronized) Surveillance reply, and thus may be used in its place for a surveillance update.

### 4.3.4 Comm-D Reply

The Comm-D reply (length 112 bits) is used for the more efficient transmission of long air-to-ground data link messages. Each Comm-D reply includes an 80-bit message field; and up to 16 Comm-D replies may be transmitted as a single long response, and acknowledged with a single interrogation. A Comm-D reply cannot be used for a surveillance update because it does not include the aircraft altitude.

## 4.4 Data Block Formats

The data block formats for each interrogation and reply type are shown in Fig. 4.4-1. A brief discussion of each field follows. Section 6, Link Operating Protocol, includes a more detailed description of the use of the control fields to effect the surveillance and data link functions.

The field definitions are divided into five types: General Fields (4.4.1), All-Call Interrogation/Reply Fields (4.4.2), Surveillance/Comm-A Interrogation Fields (4.4.3), Surveillance/Comm-B Reply Fields (4.4.4), and Special Comm-C/Comm-D Fields (4.4.5). Table 4.4-1 indexes these field definitions.

### 4.4.1 General Fields



#### 4.4.1.1 F: Format Type

The first bit of the data block, which designates the format type, as follows:

<u>F</u>	<u>Format Type</u>
0	Normal (Surveillance, Comm-A, Comm-B formats)
1	Special (All-Call, ELM formats)

#### 4.4.1.2 L: Length

The second bit of the data block, which designates the block length, as follows:

<u>L</u>	<u>Length</u>
0	56 bits
1	112 bits

#### 4.4.1.3 IT: Interrogator Type

A one-bit field which designates whether the interrogation is transmitted from a standard (IT=1) or auxiliary (IT=0) interrogator. The IT bit determines the meaning of the DABS All-Call lockout (DL) code.

In general, a standard interrogator is a DABS sensor with a directional antenna performing normal ATC surveillance and communications, while an auxiliary interrogator is an omnidirectional facility whose function is to provide synchronizing interrogations to aircraft not under DABS surveillance.

### 4.4.2 All-Call Interrogation/Reply Fields

#### 4.4.2.1 Capability

A six-bit field which designates to the interrogator the data link input/output capability of the aircraft. Each of the bits in this field is dedicated to a specific capability. A "1" in a particular bit position indicates the following:

Bit No.

- 3 Equipped with IPC/PWI Display
- 4 Equipped with ATC numeric display (Freq., Alt., Heading, Airspeed)
- 5 Equipped with ATC alphanumeric display (32 character)
- 6 Unassigned
- 7 Unassigned
- 8 Request extended capability and/or variable call sign (see 4.4.3.6)

DABS ONLY ALL-CALL INTERROGATION

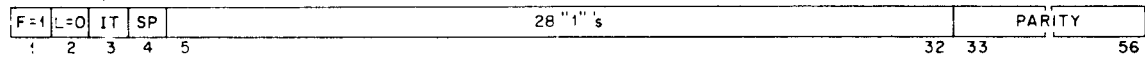

SURVEILLANCE INTERROGATIONS  
UNSYNCHRONIZED

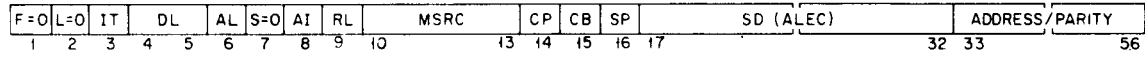

SYNCHRONIZED

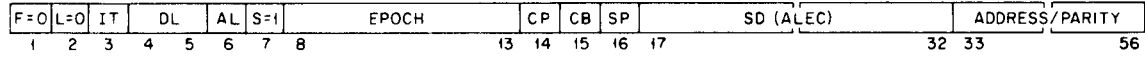

COMM-A INTERROGATIONS  
UNSYNCHRONIZED

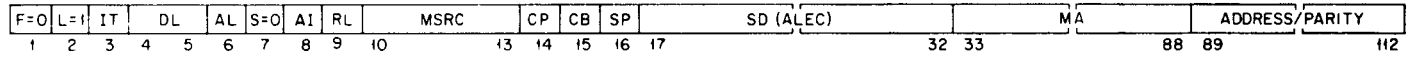

SYNCHRONIZED



COMM-C INTERROGATION

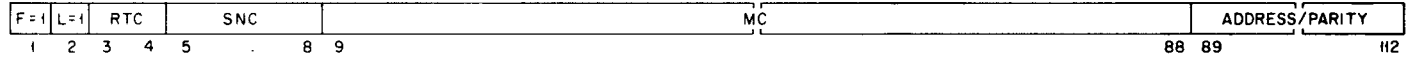

ALL-CALL REPLY

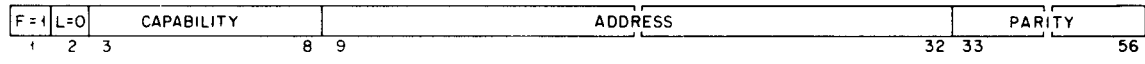

SURVEILLANCE REPLY  
UNSYNCHRONIZED

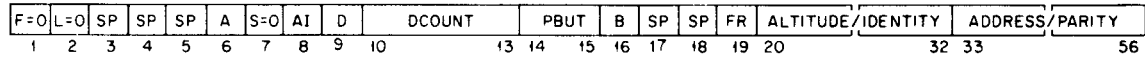

SYNCHRONIZED

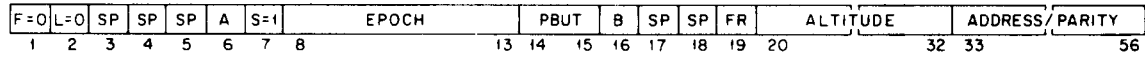

COMM-B REPLY  
ALWAYS UNSYNCHRONIZED

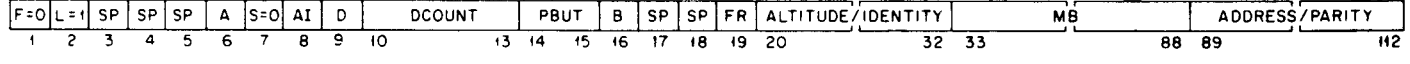

COMM-D REPLY

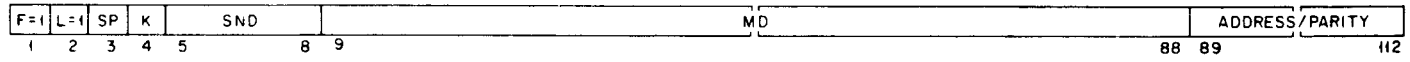

Fig. 4.4-1. Interrogation and reply formats.

FIELD NAME ABBREVIATIONS (Fig. 4.4-1).

A:	Alert	L:	Data-Block Length
AI:	Altitude/Identity Designator	MA:	Ground-to-Air Data Link Message
AL:	ATCRBS Lockout	MB:	Air-to-Ground Data Link Message
ALEC:	Altitude Echo	MC:	Ground-to-Air Extended- Length Message Segment
B:	Air-to-Ground Data Link Message Waiting	MD:	Air-to-Ground Extended- Length Message Segment
CB:	Clear Comm-B	MSRC:	Air-to-Ground Data Link Message Source
CP:	Clear PBUT	PBUT:	Pilot Acknowledgment Buttons
D:	Air-to-Ground Extended- Length Message Waiting	RL:	Reply Length
DCOUNT:	Number of Segments in Air-to-Ground Extended- Length Message	RTC:	Reply Type for Comm-C Interrogations
DL:	DABS All-Call Lockout	S:	Synchronization Indicator
EPOCH:	Synchronous Reply Time	SD:	Special Data
F:	Format Type	SP:	Spare
FR:	Flight Rules Indicator	SNC:	Segment Number of Ground- to-Air ELM Segment
IT:	Interrogator Type	SND:	Segment Number of Air-to- Ground ELM Segment
K:	Extended-Length Message Control Indicator		

Table 4.4-1. Index of field definitions.

A (4.4.4.1)	FR (4.4.4.9)
Address (4.4.2.2)	Identity (4.4.4.10)
Address/Parity (4.4.3.13 and 4.4.4.12)	IT (4.4.1.3)
AI (4.4.3.4 and 4.4.4.3)	K (4.4.5.3)
AL (4.4.3.2)	L (4.4.1.2)
ALEC (4.4.3.11)	MA (4.4.3.12)
Altitude (4.4.4.10)	MB (4.4.4.11)
AR (4.4.3.12)	MC (4.4.5.2)
B (4.4.4.8)	MD (4.4.5.3)
Capability (4.4.2.1)	MDES (6.2.4.1)
CB (4.4.3.9)	MSRC (4.4.3.6)
CP (4.4.3.8)	Parity (4.4.2.3)
D (4.4.4.4)	PBUT (4.4.4.7)
DC (6.2.4.1)	RL (4.4.3.5)
DCOUNT (4.4.4.5)	RTC (4.4.5.1)
DE (6.2.4.1)	S (4.4.3.3 and 4.4.4.2)
DL (4.4.3.1)	SA (6.2.4.1)
EPOCH (4.4.3.7 and 4.4.4.6)	SD (4.4.3.10)
F (4.4.1.1)	SNC (4.4.5.2)
	SND (4.4.5.3)

#### 4.4.2.2 Address

A 24-bit field which contains the aircraft's discrete address code.

#### 4.4.2.3 Parity

A 24-bit field which contains 24 parity check bits generated by applying a parity check code to the preceding bits in the data block. The algorithms for generating the parity check bits are described in Section 5.

#### 4.4.3 Surveillance/Comm-A Interrogation Fields

##### 4.4.3.1 DL: DABS All-Call Lockout

A two-bit field which allows the interrogator to prevent the transponder from replying to All-Call interrogations or auxiliary discrete address interrogations. The meaning of the DL code is determined by the value of the IT bit received in the same transmission, as summarized in Table 4.4-2.

Table 4.4-2. Lockout codes

DL	Function When IT = 1 (Standard Interrogator)	Function When IT = 0 (Auxiliary Interrogator)
00	Clear all DABS lockouts	Clear Aux. All-Call lockout
01	Lockout Std. All-Calls in addition to previously-set lockouts	Lockout Aux. All-Calls in addition to previously-set lockouts
10	Lockout Aux. All-Calls and Aux. Discrete-Address Interrogations	Hold current lockout state
11	Lockout Std. All-Calls, Aux. All-Calls, and Aux. Discrete-Address Interrogations	Unassigned

(Note: Standard All-Calls are ATCRBS/DABS All-Calls. Auxiliary All-Calls are DABS-only All-Calls with IT = 0. DABS-only All-Calls with IT = 1 cannot be locked out.)

##### 4.4.3.2 AL: ATCRBS Lockout

A one-bit field which allows the interrogator to prevent the transponder from replying to ATCRBS interrogations. A "1" in this field inhibits replies to ATCRBS interrogations.

#### 4.4.3.3 S: Synchronization Indicator

A one-bit field which designates whether the interrogation is synchronized, i. e., timed such that the resulting reply occurs at a precise clock time. A "1" in this field indicates that the interrogation is synchronized.

#### 4.4.3.4 AI: Altitude/Identity Designator

A one-bit field used to designate whether the reply is to contain the pressure altitude code or ATCRBS identity code in its altitude/identity field. A "1" is used to request transmission of the ATCRBS identity code.

#### 4.4.3.5 RL: Reply Length

A one-bit field used to designate the reply type (length), as follows:

<u>RL</u>	<u>Reply Type</u>
0	Surveillance (56 bits)
1	Comm-B (112 bits)

#### 4.4.3.6 MSRC: Air-to-Ground Data Link Message Source

A four-bit field used with RL=1 to initiate readout of message input devices on the aircraft (e. g., extended capability information, MLS position, automatic weather sensors, etc.). Specific codes are presently unassigned, except for MSRC=0000 and 0001, which are assigned as follows: an interrogation with RL=1 and MSRC=0000 is used following an earlier reply containing B=1 to elicit a Comm-B reply with a pilot-initiated message in MB. An interrogation with RL=1 and MSRC=0001 is used to read out the extended-capability field of an aircraft equipped for Comm-B transmission, including the voice call sign (flight number) of the aircraft if it is different from the 24-bit fixed address (see 7.2.3).

#### 4.4.3.7 EPOCH: Synchronous Reply Time

A six-bit field which designates the six most significant bits of the resulting synchronized reply time.

#### 4.4.3.8 CP: Clear PBUT

A one-bit field which is used to acknowledge and reset the pilot acknowledgment buttons. A "1" in this field indicates acknowledgment.

#### 4.4.3.9 CB: Clear Comm-B

A one-bit field which is used to acknowledge receipt of an air-to-ground Comm-B message. A "1" in this field indicates acknowledgment and causes the B bit and the contents of the MB field to be cleared. When an interrogation is received with CB=1, the B bit shall be cleared in the reply to that interrogation unless another Comm-B message is waiting; in that case, the B bit shall remain set.

#### 4.4.3.10 SD: Special Data

A 16-bit field used for transmission of short, specialized data words. If the first four bits of SD (Bits 17-20) are all zeros, the remainder of SD (bits 21-32) contains ALEC. (No other uses of SD are presently defined. However, if bits 17-20 are not all zeros, the transponder is thereby instructed not to display the contents of the remainder of the SD field in the ALEC display.)

#### 4.4.3.11 ALEC: Altitude Echo

A 12-bit sub-field of SD used when bits 17-20 are all zeros to transmit to the aircraft its altitude as reported on the previous transponder response. For convenience in display, ALEC is encoded as follows: bits 21-24 transmit the decimal integers 0-12, representing 10,000-ft increments through 120,000-ft; bits 25-28 transmit the decimal integers 0-9, representing 1,000-ft increments; bits 29-32 transmit the decimal integers 0-9, representing 100-ft increments. For aircraft flying below 18,000 ft, MSL, ALEC is corrected for local barometric pressure in the aircraft's operating area, so that the ALEC display should correspond to the aircraft altimeter readout.

(The ALEC display allows the pilot to continuously verify that the aircraft's reported altitude is the same as that indicated by the aircraft altimeter. Such a check is necessary to insure the validity of the reported altitude when used for automatic

conflict detection/resolution (e. g., IPC). In addition, the ALEC display provides continuous assurance to the pilot that he is under DABS surveillance and his equipment is functioning properly.)

#### 4. 4. 3. 12 MA: Ground-to-Air Data Link Message

A 56-bit field which contains the ground-to-air data-link message. The first bit of MA, designated AR (Acknowledgment Request), indicates whether a pilot acknowledgment of the message is desired. The first eight bits of MA include, in addition to AR, the display device address code and display control bits.

#### 4. 4. 3. 13 Address/Parity

A 24-bit field which contains the 24-bit discrete address of the interrogated aircraft combined with 24 parity bits generated by applying a parity check code to the preceding bits in the data block. The algorithms for generating the parity check bits and for their combination with the address code are described in Section 5.

#### 4. 4. 4 Surveillance/Comm-B Reply Fields

##### 4. 4. 4. 1 A: Alert

A one-bit field requesting the sensor to transmit an interrogation with AI=1 so that the ATCRBS identity (4096) code setting may be transmitted to the ground. This is the manner in which a pilot indicates an emergency condition when under DABS surveillance. It could also be used for transmitting other downlink messages if specific codes were designated for that purpose. The A bit is ordinarily set by means of a momentary-contact switch on the transponder control panel. In addition, the transponder will be designed so that the A bit is automatically set when the first two digits of the ATCRBS 4096 code are set to 76 to 77. When set by the momentary-contact switch, the A bit is cleared by the receipt of an interrogation with AI=1. When set by the ATCRBS code selector, the A bit is transmitted in all DABS replies and cannot be cleared from the ground.

#### 4.4.4.2 S: Synchronization Indicator

A one-bit field which echos the S bit in the corresponding interrogation, indicating (by S=1) that the reply is synchronized and can be used by suitably equipped aircraft for air-to-air ranging. A synchronized reply will always be a Surveillance reply with altitude. Thus, the S bit of a Comm-B reply will always be "0".

#### 4.4.4.3 AI: Altitude/Identity Designator

A one-bit field used to designate whether the altitude/identity field contains the pressure altitude code or the ATCRBS identity code. A "1" is used to indicate the presence of the ATCRBS identity code.

#### 4.4.4.4 D: Extended-Length "Message Waiting" Indicator

A one-bit field which designates to the interrogator that the transponder has an Extended-Length Message waiting to be transmitted. A "1" in this field indicates the presence of such a message.

#### 4.4.4.5 DCOUNT

A four-bit field used to indicate the length of an Extended-Length Message waiting to be sent. The four-bit binary integer in DCOUNT is one less than the number of segments in the Extended-Length Message.

#### 4.4.4.6 EPOCH: Synchronous Reply Time

A six-bit field which repeats, in a synchronized reply, the contents of the EPOCH field in the corresponding synchronized interrogation (paragraph 4.4.3.7).

#### 4.4.4.7 PBUT: Pilot Acknowledgment Buttons

A two-bit field set by the pilot to respond to an Acknowledgment Request (AR=1), or to request the transmission of a display test sequence, as follows:



<u>PBUT</u>	<u>Meaning</u>
0 0	None
0 1	Cannot comply
1 0	Will comply
1 1	Request test transmission

#### 4.4.4.8 B: Data Link "Message Waiting" Indicator

A one-bit field which designates to the interrogator that the transponder has a Comm-B message waiting to be transmitted. A "1" in this field indicates the presence of such a message.

#### 4.4.4.9 FR: Flight Rules Indicator

A one-bit field set by the pilot to indicate whether the aircraft is operating under visual or instrument flight rules. A "1" in this field designates IFR operation.

#### 4.4.4.10 Altitude/Identity

A 13-bit field which contains the ATCRBS Mode A identity code or Mode C altitude code (including the "X" bit), as indicated by the AI field.

#### 4.4.4.11 MB: Air-to-Ground Data Link Message

A 56-bit field which contains the air-to-ground data link message. The first eight bits of MB are reserved for input device address code and associated control/status bits.

#### 4.4.4.12 Address/Parity

A 24-bit field which contains the 24-bit discrete address of the replying aircraft combined with 24 parity check bits generated by applying a parity check code to the preceding bits in the data block. The algorithms for generating the parity check bits and for their combination with the address code are described in Section 5.

#### 4.4.5 Special Comm-C/Comm-D Fields

##### 4.4.5.1 RTC: Reply Type for Comm-C Interrogations

A special two-bit reply type and control field used in conjunction with an Extended-Length Message transmission. The RTC codes are defined in Table 4.4-3.

##### 4.4.5.2 SNC and MC

Respectively, 4- and 80-bit segment number and message fields included in Comm-C transmissions. The interpretation of these fields depends on the the RTC code, as defined in Table 4.4-3.

##### 4.4.5.3 K, SND, and MD

Respectively, 1-, 4-, and 80-bit fields which are used for Extended-Length Message transfer, as follows:

<u>K</u>	<u>SND</u>	<u>MD</u>
0	Segment number of message segment in MD	80-bit segment of air-to-ground Extended-Length Message
1	Not used	Cumulative transponder technical acknowledgment (TTA) of ground-to-air Extended-Length Message

Table 4.4-3. Definition of Comm-C fields.

RTC	SNC	MC	Reply	Function of Comm-C Transmission
0 0	0 0 0 1 to 1 1 1 1	Initial 80-bit Message Segment	No Reply	Contains highest-numbered segment of uplink ELM and indicates number of segments to follow
0 1	0 0 0 1 to 1 1 1 0	Intermediate 80-bit Message Segment	No Reply	Contains an intermediate segment of an uplink ELM and its segment number
1 0	0 0 0 0 to 1 1 1 0	Final 80-bit Message Segment	Comm-D with K=1 and TTA in MD	Contains last segment of uplink ELM and requests cumulative transponder technical acknowledgment (TTA)
1 1	0 0 0 0	Segment Request (SR) Field (16 bits)	Multiple Comm-D transmissions	Specifies which downlink ELM segments the transponder should transmit
1 1	0 0 0 1	Bit 9 (first bit of MC) = 1, others = 0	Single Comm-D, contents arbitrary	Concludes an uplink ELM transaction
1 1	0 0 1 0	Bit 9 (first bit of MC) = 1, others = 0	Single Comm-D, contents arbitrary	Concludes a downlink ELM transaction
1 1	0 0 1 1 to 1 1 1 1	---	---	Undefined

## 5. ERROR PROTECTION

### 5.1 Error Protection Technique

5.1.1 Parity check coding is used on DABS interrogations and replies to provide a high degree of protection against the occurrence of undetected errors.

5.1.2 Twenty-four parity check bits are generated for each DABS transmission. In all DABS interrogations and replies, except DABS-only All-Call interrogations and All-Call replies, these parity check bits are combined with the 24-bit discrete address in the interrogation or reply, thereby providing a high degree of error protection without increasing the transmitted message length.

5.1.2.1 In DABS-only All-Call interrogations and in certain other interrogations which are directed to all DABS transponders (such as one-way DME transmissions (6.2.5)), no address is transmitted. In these transmissions the parity bits are transmitted as they are generated or, in effect, combined with an address of all zeros.

5.1.2.2 In DABS All-Call replies the 24-bit address is transmitted as part of the information field. The 24 parity check bits are then transmitted as they are generated, i. e., without combining them with the address bits.

5.1.3 An error occurring in the received data block (in either the information field or the address/parity field) will, in general, modify the bit pattern in the address field at the completion of the decoding process. The probability of an undetected error, i. e., one which does not modify the address pattern after decoding, is extremely small.

5.1.4 When an error occurs in an interrogation, the transponder to which the interrogation was addressed will not recognize its address and will not reply or accept any accompanying message.

5.1.4.1 It is possible that noise or interference-induced errors will cause an aircraft to accept an interrogation which was actually addressed to another aircraft. Because of the very large number of possible addresses ( $2^{24} \approx 16$  million), the probability of occurrence of such a misdirected message is very low. Note that the aircraft receiving the misdirected message must be in the main lobe of the interrogator antenna pattern. Otherwise, the interrogation will be rejected by the DABS sidelobe suppression action.

5.1.5 In decoding the response to a discretely-addressed interrogation, the interrogator already knows the address of the replying aircraft. This fact allows the interrogator not only to detect errors in the reply, but also to correct certain error patterns without significantly compromising the reliability of error detection. The code properties permit the correction of error patterns resulting from interference due to a single ATCRBS reply.

5.1.5.1 In decoding the response to an All-Call interrogation, the decoder does not know the address of the replying aircraft. However, since the parity check bits are not combined with the address bits in the DABS All-Call reply, the error detection and correction capability is the same as in the case of responses to discretely-addressed interrogations.

## 5.2 Parity Check Sequence Generation

5.2.1 A systematic code is employed in which the 32 or 88-bit information field (of a 56 or 112-bit data block, respectively) is transmitted unmodified.

5.2.2 Twenty-four parity check bits are generated by operating on the information field with an encoder described by the following polynomial:

$$g(x) = \sum_{i=0}^{24} g_i x^i$$

where  $g_i = 1$  for  $i=0$  through 12, 14, 21, 24  
= 0 otherwise.

The detailed operation of the encoder is described in paragraph 5.4.

5.2.3 The 24 parity check bits are combined with the 24-bit discrete address (except in a DABS-only All-Call interrogation or an All-Call reply) and transmitted sequentially following the information field.

### 5.3 Address/Parity Combination

Two slightly different procedures are used for combining the address and parity check bits, one for interrogations and one for replies. The procedure used for interrogations is chosen to minimize transponder hardware complexity. The procedure used for replies is chosen to facilitate the use of error correction in reply decoding.

### 5.4 Encoder Operation

5.4.1 Figure 5.4-1 depicts a realization of the interrogator and transponder encoders. (The connection shown as a broken line is present only in the interrogator encoder.)

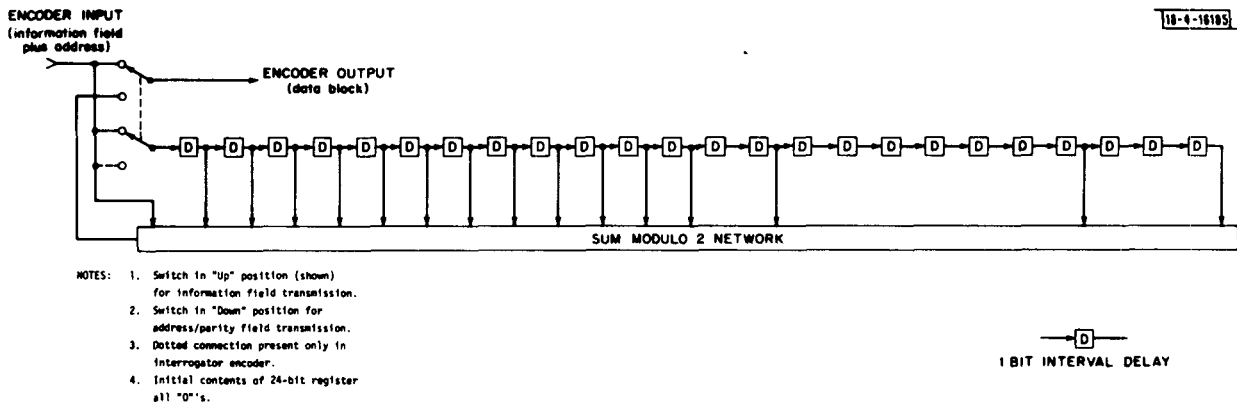

Fig. 5.4-1. Functional diagram of DABS interrogator and transponder encoders.

5.4.2 Other functionally-equivalent encoder realizations are possible. Such alternative realizations are equally acceptable, provided the address/parity field generated for all information and address fields is identical to that of the encoder in Fig. 5.4-1.

5.4.3 As illustrated, the encoder comprises a 24-stage shift register, with the outputs of certain stages, as defined by the characteristic polynomial, summed modulo 2 with the input sequence and applied to the shift register input.

5.4.4 The encoder operates in two modes, the first during the transmission of the information field, the second during the transmission of the address/parity field. In the depicted encoder, the mode is determined by the position of the switch; the position illustrated corresponds to the mode used during the transmission of the information field.

5.4.5 Encoding commences with all shift register stages initialized to "0". During transmission of the information field, the encoder output is connected directly to the input, i. e., the transmitted bits are identically the information bits. Simultaneously the information bits are summed modulo 2 with selected shift register stages and applied to the shift register input.

5.4.6 During transmission of the address/parity field, the encoder output (i. e., the sequence of bits to be transmitted) is the output of the sum-modulo-2 network. In the interrogator encoder, the address bits are applied sequentially to the shift register input as well as to the sum-modulo-2 network. In the transponder encoder, the address bits are applied only to the sum-modulo-2 network; the shift register input is set to "0" during address/parity field transmission.

## 6. LINK OPERATING PROTOCOL

The following material, primarily of an explanatory nature, describes the use of the DABS message formats in effecting the surveillance and communications functions.

### 6.1 Surveillance

#### 6.1.1 Acquisition

Acquisition of an aircraft occurs as the result of a handoff procedure from another sensor or from an All-Call reply (in the case of a "pop-up" target).

6.1.1.1 When an aircraft is acquired as the result of an All-Call reply, the Capability field designates whether the aircraft is equipped with certain basic data link output/display devices, and whether it is equipped with additional data link capability, including potential capability for transmission of a variable call sign.

6.1.1.2 Further knowledge of data link input/output capability will be required for aircraft equipped for air-to-ground transmission. This information is acquired by interrogating the aircraft with RL=1 and MSRC=0001. This interrogation elicits a Comm-B reply containing an extended capability field in MB.

6.1.1.13 If an aircraft is equipped with a device for entering a variable call sign (see 4.4.3.6 and 7.3.2) to be correlated with its fixed 24-bit address, the call sign is obtained by the sensor along with the extended-capability code.

6.1.1.4 If an aircraft is acquired as the result of a ground-to-ground handoff from another sensor, the capability information is included as part of the handoff.



### 6.1.2 DABS All-Call Lockout

When roll-call interrogations have begun on a particular target, replies to ATCRBS/DABS All-Calls and auxiliary DABS discrete address interrogations are normally locked out by transmission of the (11) code in the DL field. This code is repeated in all subsequent Surveillance and Comm-A interrogations. This procedure prevents unnecessary All-Call replies to the sensor performing surveillance on that target as well as to other DABS sensors. It also prevents the target from replying to any auxiliary sensor interrogations. Handoff of a target to another sensor is normally accomplished by sensor-to-sensor transmission of the aircraft's address and position; the receiving sensor then acquires the target by discrete address interrogations. Alternatively, the target may be removed from DABS All-Call lockout status by the first sensor so that the receiving sensor may acquire it by All-Call acquisition.

6.1.2.1 If a transponder does not receive an interrogation from a standard sensor within a fixed time (corresponding to a few interrogator antenna scans), lockout to ATCRBS/DABS All-Calls automatically lapses, thereby enabling the target for acquisition by any standard DABS sensor within range (but excluding acquisition by auxiliary sensors, since they do not transmit ATCRBS/DABS All-Calls).

6.1.2.2 A transponder cannot be locked out to DABS-only All-Calls from standard sensors (IT=1). These transmissions, which are normally not used, thereby provide a backup acquisition procedure which allows a DABS sensor to acquire any DABS target, regardless of its lockout status.

### 6.1.3 ATCRBS Lockout

When an aircraft is on the roll-call of a standard DABS interrogator, the ATCRBS lockout bit (AL) will ordinarily be set to eliminate unnecessary ATCRBS replies to ATCRBS interrogators within range of the target. The use of ATCRBS lockout may be inhibited to effect a target handover to an ATCRBS-only equipped facility, and also at certain times and/or in certain regions to accommodate the needs of military surveillance by ATCRBS interrogators.

6.1.3.1 The ATCRBS lockout lapses if no standard or auxiliary discrete address interrogations are received for a fixed time. Auxiliary sensors will not normally lock out transponders to ATCRBS interrogations. Therefore, loss of standard DABS contact will permit acquisition by any ATCRBS interrogator.

#### 6.1.4 Auxiliary Interrogator Lockout

When an aircraft is on the roll-call of a standard DABS interrogator (designated by IT=1), it will ordinarily be locked out (by DL=10 or 11) to DABS interrogations (All-Call or discretely-addressed) from an auxiliary interrogator (designated by IT=0).

6.1.4.1 If no standard or auxiliary DABS interrogations are received within a fixed time (corresponding to a few interrogator antenna scans), lockout to auxiliary interrogations lapses.

6.1.4.2 Handovers from standard DABS sensors to auxiliary sensors are accomplished as follows: When the target approaches the extreme boundary of the standard sensor coverage area, the standard sensor allows the transponder to reply to auxiliary transmissions. When the target appears on the auxiliary roll-call, the auxiliary sensor may lock out the transponder to auxiliary All-Calls. (This action does not change the standard DABS All-Call lockout status.) The target eventually flies out of contact with the standard sensor, and lockout to standard All-Calls lapses (6.1.2.1), thereby allowing the target to be automatically reacquired by a standard sensor if it flies back into a standard coverage area.

6.1.4.3 When an aircraft is on the roll-call of an auxiliary interrogator, the DABS lockout (DL) code will normally be set to 01 to prevent the aircraft from replying to DABS-only All-Call interrogations from other auxiliary interrogators. This action will not prevent the transponder from replying to ATCRBS/DABS All-Call or DABS-only All-Call interrogations from a standard interrogator.

#### 6.1.5 Surveillance Interrogation/Reply

When an aircraft is on the roll-call of a DABS interrogator, routine surveillance is performed by a single interrogation/reply cycle each interrogator antenna scan. Monopulse direction finding is used to make an accurate azimuth measurement on the basis of a single reply.

### 6.1.6 Synchronized Interrogation/Reply

Immediately following the Surveillance interrogation/reply (within the same interrogator beam dwell time), a precisely-timed interrogation is transmitted, such that the reply occurs at a specified clock time. The round-trip transmission delay, measured on the Surveillance interrogation/reply cycle, is used to determine the interrogation timing so as to achieve the desired reply timing.

### 6.1.7 Reinterrogation

An interrogator may not receive a response to an interrogation either because the transponder does not receive the interrogation and therefore does not reply, or because the reply cannot be decoded correctly. In either case, the interrogator assumes the interrogation, with any accompanying data link message, was not received by the transponder, and additional interrogations are attempted within the same beam dwell time.

## 6.2 Ground-to-Air Comm-A Data Link Message Transfer

6.2.1 Comm-A interrogations are used for ground-to-air transmission of IPC commands and other "tactical" ATC instructions. It is assumed that, before any such transfer is initiated, the ground system has knowledge of the Comm-A capability of the aircraft in question and hence of the set of permissible message types. The message is transmitted by a Comm-A interrogation with the appropriate display device code and message text in MA. The reply will ordinarily be a Surveillance reply with altitude unless some transaction involving an air-to-ground data link transmission is being carried on simultaneously. An acceptable reply received by the interrogator constitutes an implicit transponder technical acknowledgement (TTA) of the ground-to-air message. If no reply is received, the message is scheduled for one or more repeat transmissions. The transaction is not necessarily completed with receipt of an implicit TTA, however, since a pilot acknowledgment is required for some messages.

### 6.2.2 Pilot Acknowledgement of Comm-A Messages

Certain types of messages, e. g., positive IPC commands, will require pilot acknowledgment. To alert the pilot that an acknowledgment is requested, the "AR" bit in the Comm-A interrogation is set. When "AR=1" is sensed by the transponder, blinking lights are turned on at or near the pilot's YES and NO buttons and the buttons become active. (The lights and buttons are activated after a short delay to prevent the transmission of an acknowledgment which might ambiguously refer to a previous command.) When the pilot pushes an active button, the light associated with that button stops flashing but remains on, the light associated with the other button turns off, both buttons become inactive, and the appropriate code is set into the PBUT field. The PBUT signal is then transmitted to the ground as part of every Surveillance or Comm-B reply.

### 6.2.3 Resetting of Pilot Acknowledgment Signal

The signal encoded in PBUT continues to be transmitted in each Surveillance or Comm-B reply until its receipt is acknowledged by the interrogator. This acknowledgment is accomplished by transmitting an interrogation with CP=1. Receipt of CP=1 resets PBUT to 00 and turns the lights off. Note that the sequence of states of the light (flashing - steady - off) serves to indicate to the pilot the progress of the transaction.

6.2.3.1 The light is also turned off and PBUT reset under either of two other conditions: (1) interruption and recovery from a power failure in the transponder or related I/O devices, and (2) loss of standard DABS contact, defined as failure by the transponder to decode its proper address in a DABS interrogation (with IT=1) for some fixed time, equal to that of a small number of interrogator antenna scans.

### 6.2.4 Multiple-Segment Comm-A Ground-to-Air Message Transfer

Recent studies\* of ground-to-air ATC data link message requirements have indicated that a message length capability of approximately 32 alphanumeric characters is sufficient to accommodate most ATC "tactical" messages.

---

\*For example see [2].

Such message can be transferred as a succession of eight-character segments, each segment transmitted by a Comm-A interrogation, and each individually acknowledged before transmission of the succeeding segment.

#### 6.2.4.1 32-Character Display Configuration and Message Format

This section describes a possible display configuration and associated link protocol to provide 32-character data link capability. The message display consists of four sections, each capable of displaying eight alphanumeric characters. All of the sections of the display are accessed by means of a single device address code. Six bits are used to encode each alphanumeric character; thus, 48 bits are required to display each eight-character section. The remaining 8-bits form a message control field which includes the AR bit, a 3-bit device address code (MDES = 000 for this display), and four control bits. Two of these bits, designated Display Clear (DC) and Display Enable (DE), control the display operations as follows:

A message segment containing DC=1 clears all four sections of the display and associated memory.

A message segment containing DE=0 blanks (i. e., turns off) all four sections of the display, but does not erase the contents of the display memory registers.

A message segment containing DE=1 activates (i. e., turns on) all four section of the display.

Two additional bits, designated Section Address (SA) bits, are used to indicate the segment number (0 through 3) of the associated message segment, and define which section of the display is to be used for that message segment. Figure 6.2-1 depicts the tentative message format.

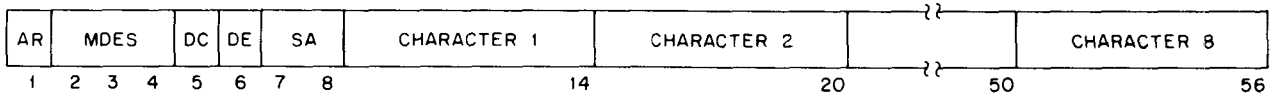

AR: Acknowledgment Request.  
 DC: Display Clear 0 = No action  
       1 = Clear  
 DE: Display Enable 0 = Blank  
       1 = Display  
 MDES: Display Device Code  
 SA: Section Address

Fig. 6.2-1. MA field format for multiple-segment ground-to-air messages.

#### 6.2.4.2 Link Protocol for Complete Ground-to-Air Message

Transmission of a complete message (all display sections updated) is initiated with a Comm-A interrogation with the appropriate MDES, and with DC=1 and DE=0 or 1 (depending on whether the message segments are to be displayed as received, DE=1, or not until the total message is delivered, DE=0.) If this is the only segment to be transmitted, DE=1. SA can have any allowable value, depending on the desired display format and order of transmission. This segment, and all subsequent ones, must be acknowledged by receipt of the transponder reply prior to transmission of a subsequent segment; if the reply is not received, the same segment is retransmitted. As soon as this reply is received, the next segment may be transmitted. This and subsequent segments of the same message are transmitted with DC=0 in order not to erase already transmitted segments; again, DE may be 0 or 1, except that on the final segment DE must be 1 in order to activate the display. If pilot acknowledgment of the message is required, the AR bit is set in the Comm-A interrogation containing the final segment.

#### 6.2.4.3 Section Update

Any section of the display may be modified by the transmission of a single segment with DC=0 and DE=1. This action overwrites the new segment into

the display section designated by the SA bits; the other display sections are unaffected by this transmission. As in the case of a complete message, the transponder reply acknowledges receipt of the segment. A pilot acknowledgment may be requested by setting the AR bit.

#### 6.2.4.4 Scheduling of Multiple-Segment Comm-A Messages

Normally, the delivery of a complete multiple-segment message will be accomplished within the single-scan dwell time, i. e., within a few tens of milli-seconds. However, the protocol described above permits delivery to be accomplished over a succession of scans if sensor loading or channel interference prevents complete delivery within one dwell time.

#### 6.2.5 One-Way DME

The DABS interrogation formats can also be used for one-way DME transmissions from an interrogator which periodically transmits DABS interrogations with all zeros in the address field. When it receives a Surveillance or Comm-A interrogation with an address of all zeros, the transponder transfers the contents of the uplink data block to the data link interface, but does not reply or respond to the control fields of the interrogation in any other way. The special data field or the MA field or both may contain subfields indicating the identity and location of the interrogator. If the interrogation is synchronized, the time of transmission of the interrogation is indicated in either the EPOCH field or the MA field. A DME device attached to the data link interface of the transponder can then compare the time of transmission with its internal synchronized clock (time of receipt) to determine the distance to the sensor.

### 6.3 Air-to-Ground Comm-B Data Link Message Transfer

The Comm-B air-to-ground data link carries two kinds of message traffic: (1) ground-initiated, for readout of on-board instrumentation, and (2) pilot-initiated.

### 6.3.1 Ground-Initiated Transfer of Comm-B messages

A ground-initiated transfer begins with a request in the form of a Surveillance interrogation with a long reply specified (RL=1). The MSRC field is set to indicate the device from which the data readout is wanted. This message triggers an immediate Comm-B reply with an MB field containing the MSRC code and the requested data. No acknowledgments are involved in the case of ground-initiated Comm-B transactions; failure to receive the data correctly on the ground simply causes a repeat of the request. Note that a Comm-B reply includes all the surveillance information of a Surveillance reply. For this reason a separate surveillance transaction is not needed on a scan when a ground-initiated Comm-B is planned. In fact, for aircraft equipped with suitable instrumentation providing data useful for surveillance, (e.g., readout of position derived from Microwave Landing System instrumentation) the two functions can be completely merged and all surveillance can take place by means of Comm-B replies.

### 6.3.2 Pilot-Initiated Transfer of Comm-B Messages

A pilot-initiated Comm-B message is started by setting up the message text on an input device and pushing a "Send" button, causing the B bit to be set to "1". This B bit is transmitted with every Surveillance or Comm-B reply. Receipt of this B bit causes the interrogator to send a ground-to-air transmission (either Surveillance or Comm-A) with RL=1 and MSRC=0000; the transponder responds with the waiting Comm-B reply, with the source code corresponding to the device whose "Send" button was pushed and the message text in MB.

#### 6.3.2.1 Ground Technical Acknowledgment of Pilot-Initiated Comm-B Messages

Because of the asymmetry between sensor and transponder (with the sensor not routinely replying to every air-to-ground transmission), an explicit ground technical acknowledgment is required. When the air-to-ground message is successfully received by the sensor, the CB bit is set to "1" in the next interrogation. When CB=1 is received by the transponder, the B bit is cleared and the "Send" button on the input device is unlatched. The transaction is then complete.



### 6.3.3 Multiple-Segment Comm-B Air-to-Ground Message Transfer

While no specific requirements have been identified at this time, it is possible that certain air-to-ground messages initiated by non-ELM-equipped aircraft will require more than 56 bits for transmission. As in the case of a multiple-segment ground-to-air message (paragraph 6.2.4), such messages can be accommodated by a succession of Comm-B replies, each acknowledged by the interrogator before transmission of the next. The message input device would incorporate the necessary bookkeeping functions, including reinitiating an air-to-ground transfer (i. e. , resetting the B bit to "1") following the acknowledgment of the preceding segment by the interrogator. Any necessary link control and/or segment labeling bits would be contained within the control subfield within the MB field.

### 6.4 Comm-C/Comm-D Extended-Length Message Protocol

Extended-Length Message (ELM) protocol provides for more efficient transmission of long data link messages by permitting the grouping of up to 16 message segments into a single entity which can be acknowledged by a single reply. Each segment is included in a single Comm-C or Comm-D transmission. (The limit of 16 segments refers solely to the manner in which the message is transferred over the link. Longer messages can be accommodated through the use of a message continuation indicator within the text field of the last segment of an ELM.)

#### 6.4.1 Ground-to-Air Extended-Length Message Transfer

Ground-to-Air Extended-Length Messages are transmitted using the Comm-C format with three different reply type codes (RTC=00, 01, and 10) as defined in paragraph 4.4.5.1. The three reply type codes designate an initializing segment, intermediate segments and a final segment. (Note that the minimum length of a ground-to-air ELM is two segments.) The transfer of all segments may take place without any intervening air-to-ground replies, as described in the next four paragraphs. In this way, channel loading is minimized. Message segments (one per Comm-C interrogation) may be

transmitted at a rate up to one per 50  $\mu$ sec. This minimum spacing is required to permit the resuppression of ATCRBS transponders. Delivery of the message may take place during a single scan or over a few scans depending on the length of the message, the channel interference level, and the sensor loading. Normally, sufficient time will be available within one scan to permit complete delivery of the message.

#### 6.4.1.1 Initializing Segment Transfer

The Extended Length Message transaction for an N-segment message (segment numbers 0 through N-1) is initiated by a Comm-C interrogation with RTC=00. The transponder does not reply. Receipt of this interrogation (in effect a "dial up") causes the ELM interface within the transponder to initialize its message storage and bookkeeping registers in preparation for a new ELM transfer. Also delivered in the initial call is the text of the final message segment in MC, and its segment number (N-1) in the SNC field. This "last segment first" protocol is used to inform the transponder of the length of the message. If an initializing segment is received before the completion of an earlier ground-to-air ELM transfer, the effect is to abort the earlier message and replace it with the newer one. If the ELM processor fails to receive an initializing segment, it will ignore all further segments of the same message.

#### 6.4.1.2 Intermediate Segment Transfers

Message delivery proceeds with the transmission of intermediate segments (any sequence of N-2 segments chosen from segments N-2 through 0) via Comm-C interrogations with RTC=01, again triggering no replies. Each message segment is identified with its segment number in the SNC field. The ELM processor stores each segment in the appropriate storage location based on this number. In this way, the message processor reassembles the message, and its bookkeeping function keeps track of which segments have been received. Note that intermediate segments may be delivered in any order, once the ELM processor has been initialized with segment N-1. If the entire message consists of only two segments, there will be no intermediate transfers.

#### 6.4.1.3 Final Segment Transfer

The interrogator transmits the final segment of a Comm-C interrogation with RTC=10. Its segment number is in SNC and the text in MC as before. This RTC code elicits a Comm-D reply with K=1 and a cumulative transponder technical acknowledgment in the MD field. The cumulative transponder technical acknowledgment (TTA) consists of a bit string (maximum length 16 bits) which indicates which segments of the ELM have been received. The first bit represents the state of the first (N=0) segment, etc., with the states defined as: 1 = segment received, and 0 = segment not received. Thus at all times this field represents the current status of segment delivery from the time of ELM initiation. If the interrogator does not receive a reply to the Comm-C interrogation containing the final segment, this interrogation is repeated until a reply is successfully received. When all segments have been received, by the transponder, the interrogator knows that its last transfer was indeed final and closes out the transaction by the transmission of a Comm-C interrogation with RTC=11, SNC=0001, and bit 9=1, thereby resetting the TTA field in the transponder. This Comm-C interrogation elicits a single Comm-D reply (with arbitrary message content) which serves as a technical acknowledgment to the interrogator. The ELM processor in the transponder transfers the message to the appropriate output device as soon as it senses the presence of all segments.

6.4.1.4 If one or more segments of the ELM were not received by the transponder, this fact is indicated by zeros in the corresponding bit positions in the TTA. The interrogator retransmits the missing segments with RTC=01, except for the final one which has RTC=10 to request an updated TTA. This process continues until the ground receives a cumulative TTA indicating that all segments have been delivered. At that point, the transaction is closed out as described above.

#### 6.4.2 Air-to-Ground Extended Length Message Transfer

The transfer of an air-to-ground ELM is similar to the ground-to-air process. Differences between the two protocols result primarily from the facts that (1) all channel activity is ground initiated and (2) the transponder can

reply with a longer communications format only when given specific permission by the ground.

#### 6.4.2.1 Initialization

An N-segment air-to-ground ELM transfer is initiated by a non-synchronized Surveillance or Comm-B reply containing the D bit set to 1, and DCOUNT set to N-1. The interrogator is fully initialized as soon as it receives this information.

6.4.2.2 The interrogator requests the air-to-ground transmission of ELM segments using a single Comm-C transmission with RTC=11. In this format, the SNC field contains all zeros and the first 16 bits of MC form a special 16-bit Segment Request(SR) field, in which the successive bit positions correspond to segment numbers 0 through 15. The designated response is a series of Comm-D replies containing those message segments for which the corresponding SR bit is set to one. (The transponder is thus not told which segments have been successfully received, but those which are to be transmitted.) The successive Comm-D replies of the response are transmitted with a nominal spacing of 136  $\mu$ sec between preambles (16  $\mu$ sec between the end of a reply and the succeeding preamble). After the complete response to the Comm-C interrogation has been received, another Comm-C interrogation with an updated SR field is transmitted to request segments not yet received (either because they were not requested in the first response, or because they were received in error). The transponder replies again with the requested segments. The cycle is repeated until all segments have been received. As with uplink ELM's, this process may take place within a scan or over several scans.

6.4.2.3 Although the precise spacing of segments in the response is known to the interrogator, each segment is transmitted as a full Comm-D reply with a preamble in order to resynchronize the reply decoder in case the preceding segment is lost.

6.4.2.4 When all segments have been received, the complete message is transferred to the designated recipient. The transaction is terminated by a Comm-C interrogation with RTC=11, SNC=0010, and bit 9=1. This interrogation resets the D-bit and DCOUNT field. It also elicits a single Comm-D reply (with arbitrary contents in the MD field) which serves as a technical acknowledgment to the interrogator.

#### 6.4.3 Message Priorities

The ground processor which has control of message traffic services ground-to-air messages in the order received except when a user-supplied priority tag indicates otherwise. The existence of a small number of priority message classes permits, for example, an urgent IPC command to move ahead of other waiting messages. For air-to-ground messages, the possible priority classes are more limited, since there is less advance knowledge of the message parameters. However, ELM transfers are generally regarded as having lower priority than Comm-A or Comm-B messages. Delivery of a ground-to-air ELM can be interrupted at any time to permit the delivery of an IPC or other urgent Comm-A message, and then resumed. Similarly, a Comm-B message can interrupt an air-to-ground ELM. Message numbering (as opposed to segment numbering) is not required for this protocol; if desired by the user, message ID's may be coded within the message text.

## 7. DISCRETE ADDRESS CODE ASSIGNMENT

### 7.1 General

7.1.1 The 24 address bits provide for more than 16 million different address codes, allowing assignment of a unique address code to every aircraft. The address code will then provide positive identification of each aircraft under ATC surveillance.

7.1.2 Address codes could be assigned arbitrarily, with no relationship to other means of identifying an aircraft. However, it appears operationally convenient to assign address codes in a manner directly related to the normal ATC voice call sign of the aircraft. This convention will eliminate the need for including the beacon code as a separate item in a flight plan, and will permit an Air Traffic Controller to correlate an observed target with an air/ground voice contact without requiring a prestored conversion table.

7.1.3 Two categories of voice call signs are in common use: call signs which are uniquely and permanently associated with a particular aircraft; and call signs which are associated with a particular flight operation.

7.1.3.1 Flight operations other than air carrier and some military use the aircraft registration "number" (e.g., N3215A, G-BZAC) as the voice call sign.

7.1.3.2 Domestic Air Carrier operations use the flight number (e.g., TW531, BA762) as the voice call sign.

7.1.3.3 Military operations use either a call sign related to the aircraft registration number (e.g., Air Force 340), or a call sign assigned to a particular flight operation (e.g., Bravo 1).

7.1.3.4 International commercial flights employ a 7-character "trip number" conforming to the international aircraft identification procedure specified in ICAO Document No. 4444-RAC/501/10.

## 7.2 Recommended Code Assignment Procedure

7.2.1 The 24-bit transponder discrete address is used for fixed codes only. The aircraft's variable call sign, if different from the fixed code, is transmitted in a Comm-B reply.

### 7.2.2 Fixed Codes

A specific procedure is defined in Table 7.2-1 for coding the 24-bit address to correspond to the four common registration formats (six digits, four digits plus one letter, three digits plus two letters, and four letters). In each case, the leading letter(s), designating country of origin, are omitted.

7.2.2.1 Address codes employ the following conventions: All decimal numbers are coded in natural binary, each letter is represented by the 5-bit binary equivalent of its numerical order in the alphabet (e.g., 00001=A). Bits 1-4 comprise a control code which defines the format of the remainder of the address.

Table 7.2-1. Address code formats.

Bit Number																							
1 2 3 4	5 6 7 8 9	10 11 12 13 14	15 16 17 18 19	20 21 22 23 24																			
0 0 0 0	[ three-digit number ]	[ three-digit number ]																					
0 0 0 1	[ three-digit number ]	[ 1-digit number ]	[ one letter ]																				
0 0 1 0	[ three-digit number ]	[ one letter ]	[ one letter ]																				
0 0 1 1	[ one letter ]	[ one letter ]	[ one letter ]	[ one letter ]																			
0 1 0 0	} = Unassigned																						
to																							
1 1 1 1																							

### 7.2.3 Variable Codes

The variable code assigned to the aircraft flight is included in the 56-bit Comm-B extended-capability report which is transmitted in response to an interrogation with RL=1, MSRC=0001. The variable code may then be correlated with the transponder's address by the ground facility when it first establishes contact with the aircraft. The Comm-B message field provides sufficient capacity for encoding full 7-character international aircraft identification numbers in addition to the extended-capability code. Specific variable code assignments are not designated at this time.



## REFERENCES

- [1] T. S. Amlie, "A Synchronized Discrete-Address Beacon System," IEEE Trans. on Comm., Vol. COM-21, No. 5, pp. 421-426, (May 1973).
- [2] P. Mpontsikaris, "Correlation of Short Message Display Capabilities with ATC Message Length," Interim Report #1, DOT-TSC, Cambridge, Mass., (4 May 1973).